

FR/ Annexe	ES/ Apéndice	PT/ Anexo	IT/ Appendice
EL/ Παράρτημα	PL/ Załącznik	RU/ Приложение	UK/ Додаток
RO/ Anexa	EN/ Appendix		

Ean code	**Model No.	size(mm)	profile
3276005999367	RE-SL100-S-C	1000x1950	bright chrome
3276005999480	RE-SL100-M-C	1000x1950	mat black
3276005999442	RE-SL100-B-S	1000x1950	brushed silver nickle
3276005999404	RE-SL100-B-C	1000x1950	brushed silver nickle
3276000230205	RE-SL110-S-C	1100x1950	bright chrome
3276000230274	RE-SL110-M-C	1100x1950	mat black
3276000230229	RE-SL110-B-S	1100x1950	brushed silver nickle
3276005999527	RE-SL120-S-C	1200x1950	bright chrome
3276005999640	RE-SL120-M-C	1200x1950	mat black
3276005999602	RE-SL120-B-S	1200x1950	brushed silver nickle
3276005999565	RE-SL120-B-C	1200x1950	brushed silver nickle
3276000230298	RE-SL130-S-C	1300x1950	bright chrome
3276000230328	RE-SL130-M-C	1300x1950	mat black
3276000230311	RE-SL130-B-S	1300x1950	brushed silver nickle
3276005999688	RE-SL140-S-C	1400x1950	bright chrome
3276005999800	RE-SL140-M-C	1400x1950	mat black
3276005999763	RE-SL140-B-S	1400x1950	brushed silver nickle
3276005999725	RE-SL140-B-C	1400x1950	brushed silver nickle
3276000230342	RE-SL150-S-C	1500x1950	bright chrome
3276000230373	RE-SL150-M-C	1500x1950	mat black
3276000230366	RE-SL150-B-S	1500x1950	brushed silver nickle
3276005999848	RE-SL160-S-C	1600x1950	bright chrome
3276005999923	RE-SL160-M-C	1600x1950	mat black
3276005999886	RE-SL160-B-S	1600x1950	brushed silver nickle
3276005999961	RE-SL170-S-C	1700x1950	bright chrome
3276000230410	RE-SL170-M-C	1700x1950	mat black
3276000230403	RE-SL170-B-S	1700x1950	brushed silver nickle
3276000230427	RE-SL180-S-C	1800x1950	bright chrome
3276000230458	RE-SL180-M-C	1800x1950	mat black
3276000230441	RE-SL180-B-S	1800x1950	brushed silver nickle

SENSEA

REMIX

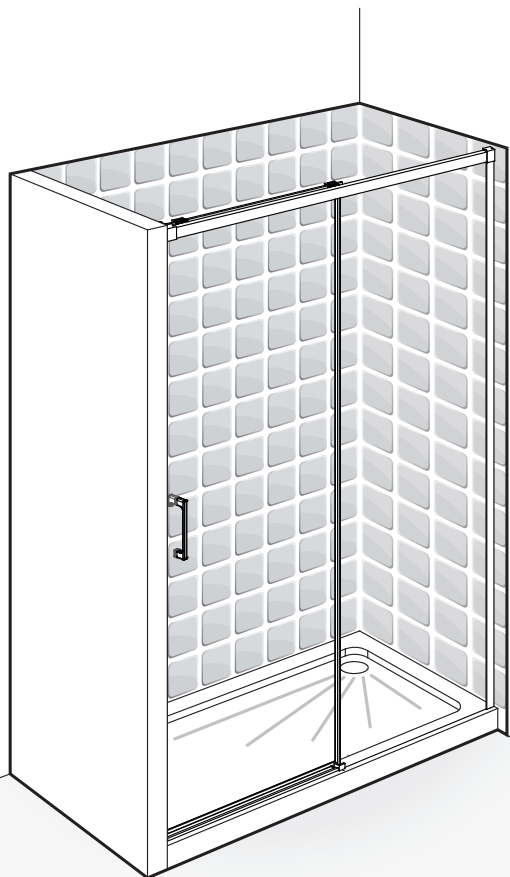

- FR** Notice de Montage, Utilisation, Entretien
- ES** Instrucciones de Montaje, Utilización y Mantenimiento
- PT** Instruções de Montagem, Utilização e Manutenção
- IT** Istruzioni per il Montaggio, l'Uso e la Manutenzione
- EL** Εγχειρίδιο συναρμολόγησης, χρήσης και συντήρησης
- PL** Instrukcja Montażu, Użytkowania i Konserwacji
- RU** Руководство По Сборке и Эксплуатации
- UK** Керівництво По Збірці і Експлуатації
- RO** Manual asamblare, utilizare și întreținere
- EN** Assembly - Use - Maintenance Manual

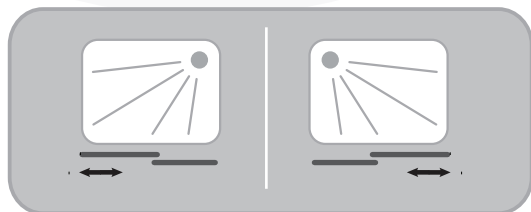

Traduction de la version originale du mode d'emploi / Traducción de las Instrucciones originales / Tradução das Instruções Originais / Traduzione delle istruzioni originali / Μετάφραση των πρωτότυπων οδηγιών / Tłumaczenie instrukcji oryginalnej / Перевод оригинала инструкции / Переклад оригінальної інструкції / Traducerea instrucțiunilor originale / Original Instructions

2016/08

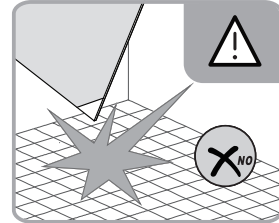
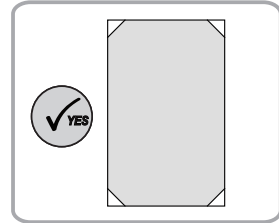
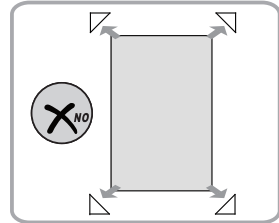
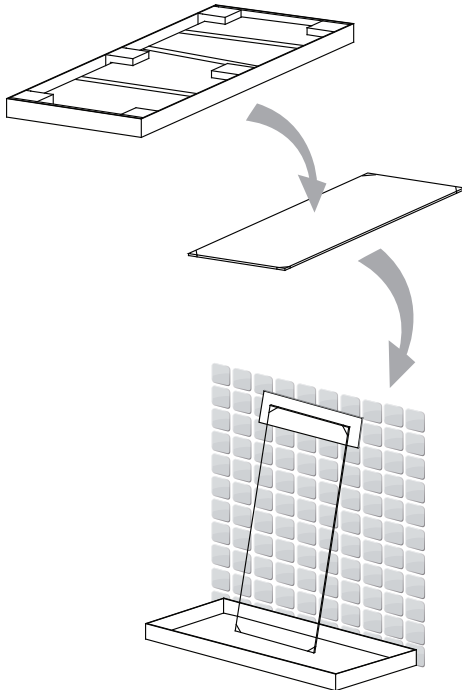
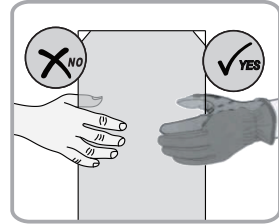
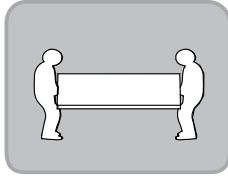
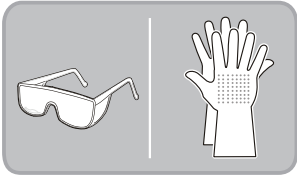
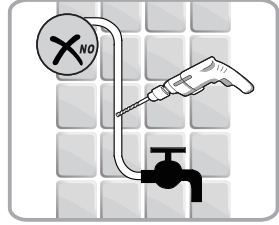
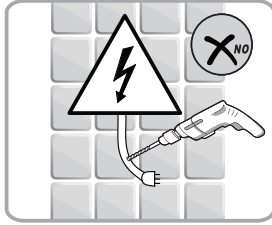
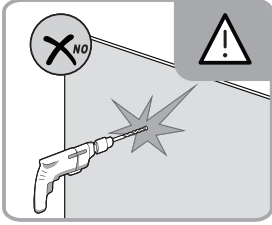

FR Vérifiez que les chevilles murales fournies sont appropriées à votre mur (celles fournies dans l'emballage sont conçues pour le béton). Sinon, utilisez des vis et des chevilles murales adaptées au type de matériau de votre mur. Pour obtenir des conseils concernant les vis et les chevilles appropriées à votre mur, demandez à un vendeur spécialisé.

ES Compruebe que todos los tacos suministrados puedan ser utilizados con su pared (los incluidos en la caja son para hormigón). En caso contrario, utilice tornillos y tacos de pared apropiados para el material de su pared. Para información acerca de las fijaciones y tornillos apropiados para su pared, consulte con un asistente de ventas especializado.

PT Certifique-se de que as buchas fornecidas são adequadas à sua parede (as fornecidas na embalagem são para betão). Caso contrário, use parafusos e buchas adequados ao tipo de material da sua parede. Para se aconselhar acerca dos parafusos e buchas adequados à sua parede, fale com um assistente de vendas especializado.

IT Verificare che i tasselli da parete forniti siano compatibili con la propria parete (quelli forniti con l'articolo sono per cemento). Altrimenti, utilizzare viti e tasselli adatti per la superficie della propria parete. Per ottenere consigli e suggerimenti sulle viti e i tasselli più adatti alla propria parete, consultare un rivenditore specializzato.

EL Βεβαιωθείτε ότι οι παρεχόμενες στερεώσεις τοίχου είναι κατάλληλες για τον τοίχο σας (οι παρεχόμενες στη συσκευή προορίζονται για μπετό). Αλλιώς χρησιμοποιήστε βίδες και στερεώσεις τοίχου κατάλληλες για τον τύπο υλικού του τοίχου σας. Για να λάβετε συμβουλές σχετικά με τις κατάλληλες βίδες και τα εξαρτήματα για τον τοίχο σας, ρωτήστε έναν ειδικό πωλητή.

PL Prosimy sprawdzić, czy dostarczone kołki do ścian nadają się do użycia w posiadanej ścianie (kołki dostarczone w zestawie są przeznaczone do betonu). Jeśli tak nie jest, należy użyć śrub i kołków odpowiednich do materiału, z którego wykonana jest ściana. Aby uzyskać poradę w sprawie śrub i elementów montażowych odpowiednich do danego typu ściany, należy zwrócić się z pytaniem do wyspecjalizowanego sprzedawcy.

RU Убедитесь, что прилагаемые дюбеля подходят для ваших стен (входящие в комплект дюбеля предназначены для бетона). В противном случае используйте шурупы и дюбеля, соответствующие материалу стены. Для получения рекомендаций по выбору шурупов и крепежных деталей, подходящих для вашей стены, обратитесь к специалисту-консультанту.

UK Перевірте, що анкери підходять для вашої стіни (ті, що постачаються в упаковці – для бетону). В іншому випадку використовуйте гвинти й стінові анкери, що відповідають матеріалу вашої стіни. Для отримання консультацій щодо гвинтів й фітінгів для вашої стіни зверніться до відповідного продавця-консультанта.

RO Verificați ca toate ancorele de perete furnizate să fie adecvate pentru peretele dumneavoastră (cele furnizate în pachet sunt pentru beton). În caz contrar, folosiți șuruburi și ancore de perete adecvate pentru tipul de material din care este peretele dumneavoastră. Pentru a obține recomandări privind șuruburile și armăturile adecvate pentru peretele dumneavoastră, întrebați un vânzător specializat.

EN Check that wall anchors provided are suitable for your wall (those provided in the package are for concrete). Otherwise, use screws and wall anchors suited to the type of material of your wall. To obtain advice on the screws and fittings suited to your wall, ask a specialized sales assistant.

2



3M

Assemble with this side, with easy clean treatment, on the inside.

İze karışı işleminde tabi tutulmuş bu yüzü iç tarafa doğru konumlanmalıdır.

Cette face, avec un traitement facilement nettoyable, doit être positionnée vers l'intérieur.

Esta cara está tratada para facilitar su limpieza y se debe colocar hacia el interior.

Esta face com tratamento para facilitar a limpeza, deve ficar voltada para o interior.

Questo lato, deve essere posizionato con il trattamento easy clean all'interno.

Эта сторона, обработанная средством против образования накипи, должна быть обращена вовнутрь.

Сторона, оброблена засобом проти накипу, повинна бути звернена всередину.

Această față, tratată pentru curățare ușoară, trebuie poziționată spre interior.

Strona z powłoką zapewniającą łatwe czyszczenie powinna być skierowana do wewnątrz.

Αυτή η όψη, με επεξεργασία για εύκολο καθαρισμό, πρέπει να τοποθετηθεί προς το εσωτερικό.

V.7 2014



Attention danger / Atención: Peligro / Atenção perigo / Attenzione pericolo / Προσοχή κίνδυνος /
Uwaga niebezpieczeństwo / Внимание! Опасно! / Увага! Небезпечно! / Atenție, pericol / Caution danger



Correct / Correcto / Correcto / Corretto / Σωστό / Dobrze / Правильный /
Правильно / Corect / Correct



Incorrect / Incorrecto / Incorrecto / Errato / Λάθος / Žle / Неправильный /
Неправильно / Incorect / Incorrect

Notes / Observaciones / Notas / Note / Σημειώσεις / Notatki / Примечания / Примітки / Note / Notes

FR Préparation

ES Preparación

PT Preparação

IT Preparazione

EL Προετοιμασία

PL Przygotowanie

RU Подготовка

UK Підготовка

RO Pregătire

EN Preparation

A

2h

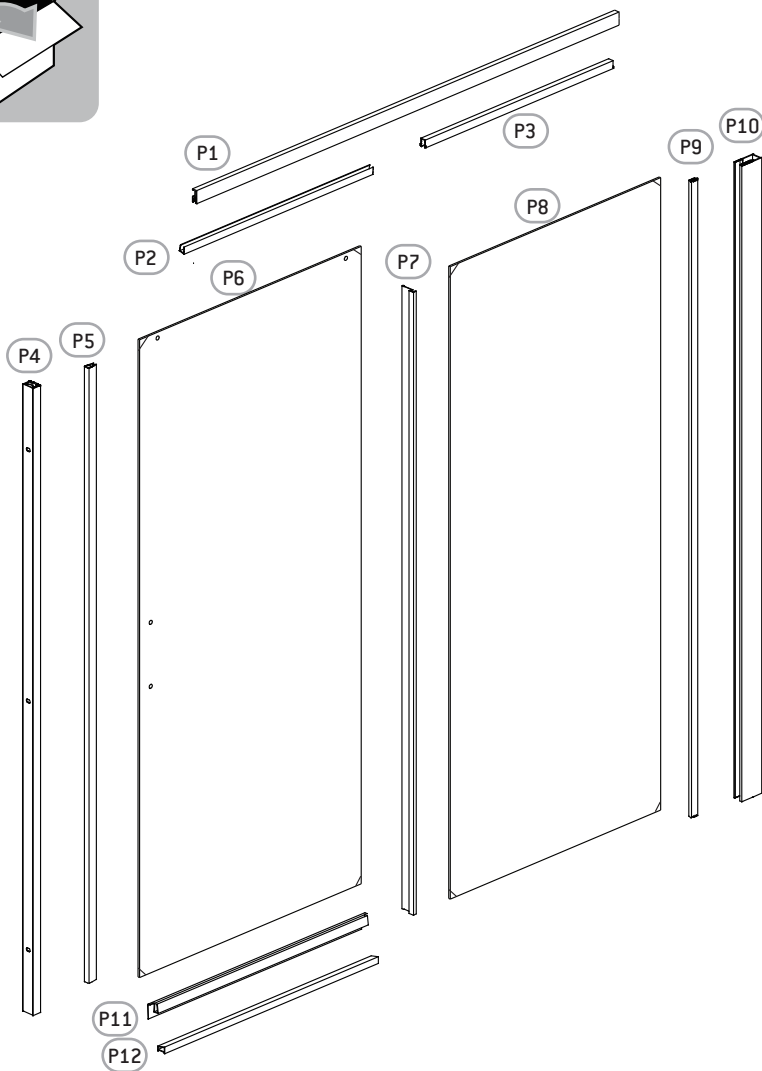
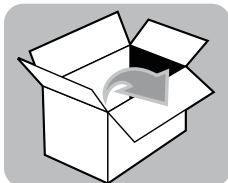

A

FR Préparation

ES Preparación

PT Preparação

IT Preparazione

EL Προετομασία

PL Przygotowanie

RU Подготовка

UK Підготування

RO Pregătire

EN Preparation

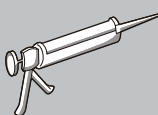
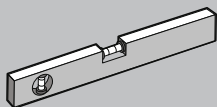
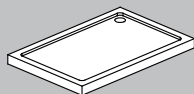
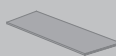
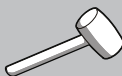
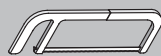
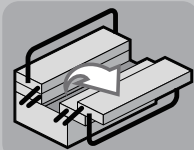
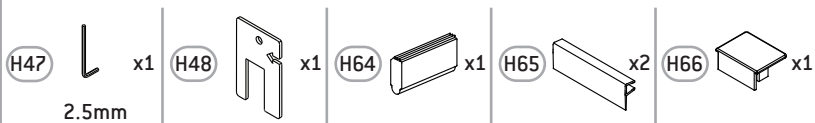
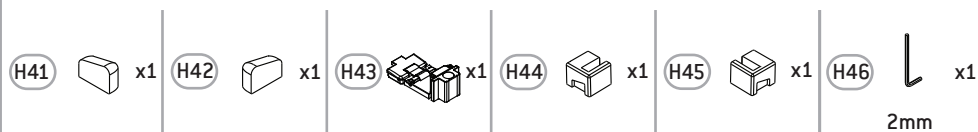
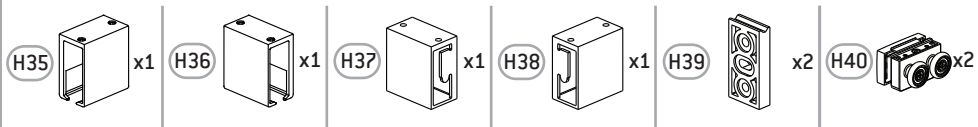
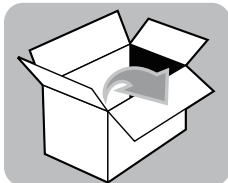

FR Montage

ES Montaje

PT Montagem

IT Montaggio

EL Συναρμολόγηση

PL Montaż

RU Сборка

UK Збірка

RO Montaj

EN Assembly

B

1

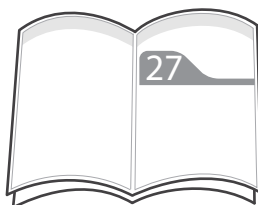
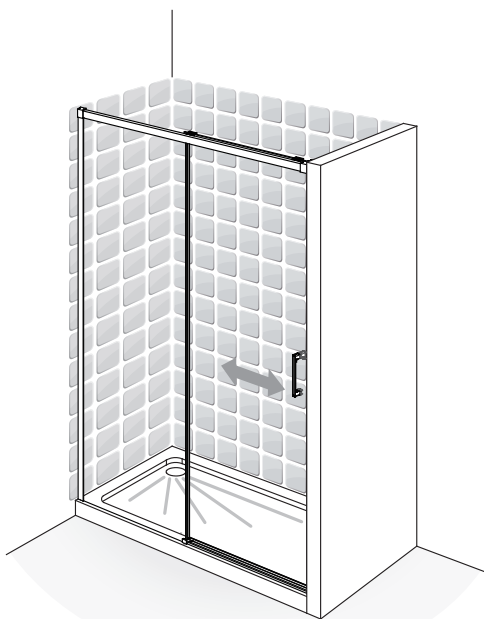
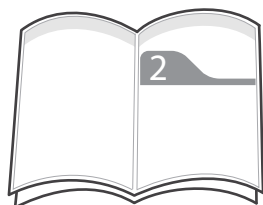
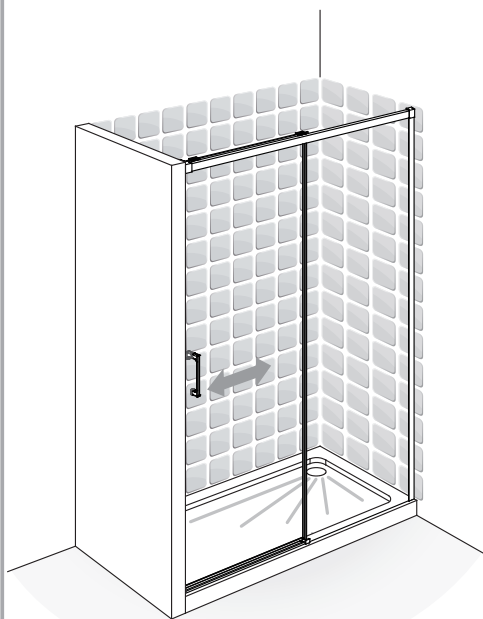

B

FR Montage

ES Montaje

PT Montagem

IT Montaggio

EL Συναρμολόγηση

PL Montaż

RU Сборка

UK Збірка

RO Montaj

EN Assembly

2

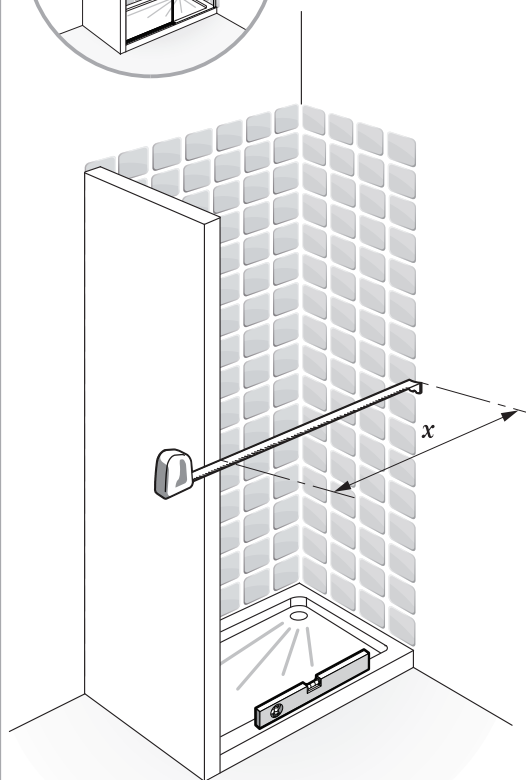
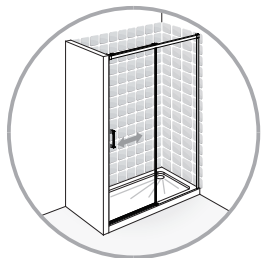

REMIX	X(mm)
1000mm	970 - 1000
1100mm	1070 - 1100
1200mm	1170 - 1200
1300mm	1270 - 1300
1400mm	1370 - 1400
1500mm	1470 - 1500
1600mm	1570 - 1600
1700mm	1670 - 1700
1800mm	1770 - 1800

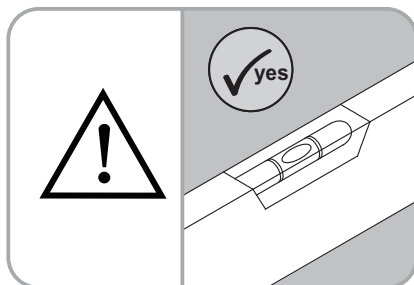
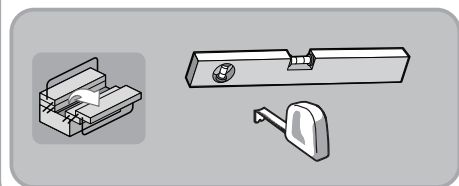

FR Montage

ES Montaje

PT Montagem

IT Montaggio

EL Συναρμολόγηση

PL Montaż

RU Сборка

UK Збірка

RO Montaj

EN Assembly

B

3

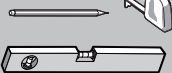
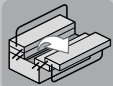
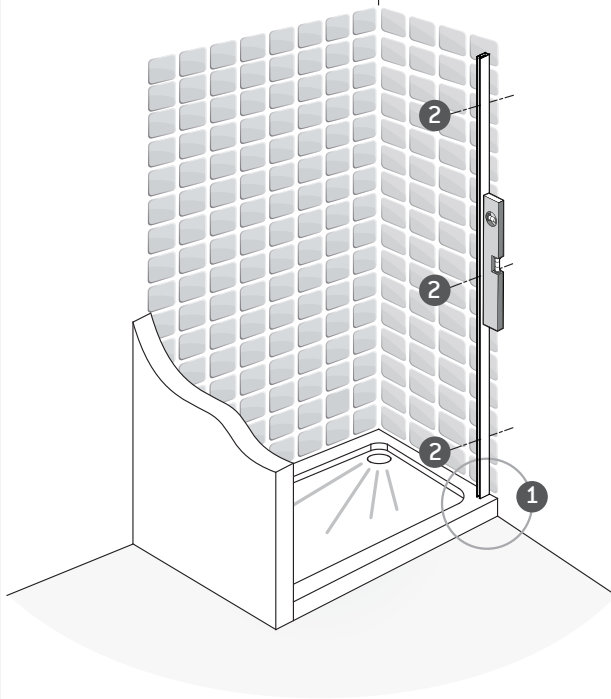
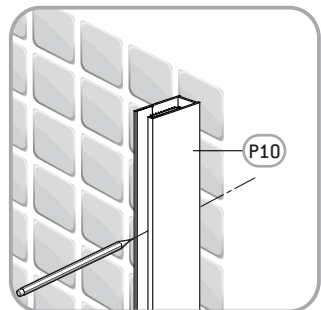
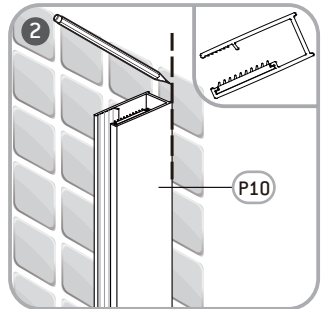
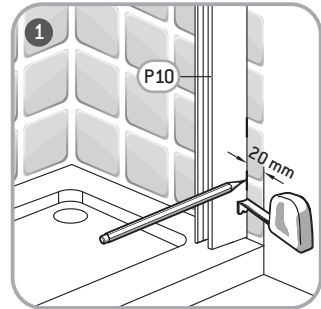

P10

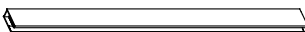

x1



B

FR Montage

ES Montaje

PT Montagem

IT Montaggio

EL Συναρμολόγηση

PL Montaż

RU Сборка

UK Збірка

RO Montaj

EN Assembly

4

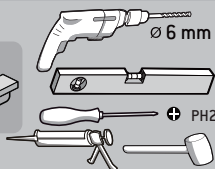
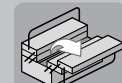
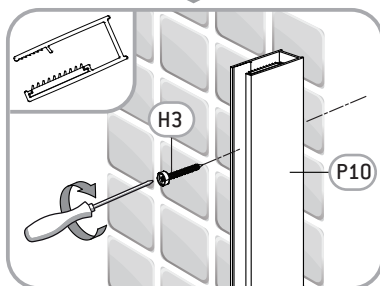
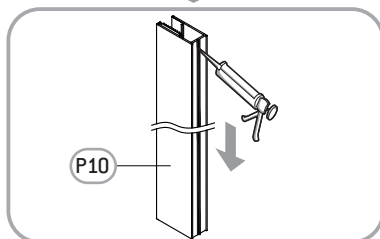
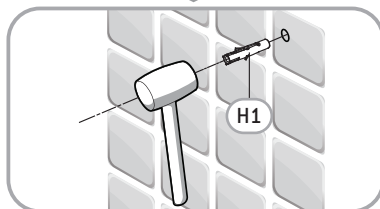
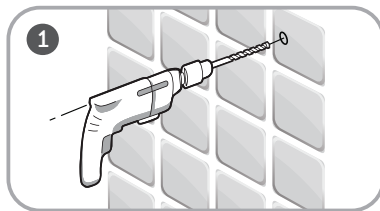
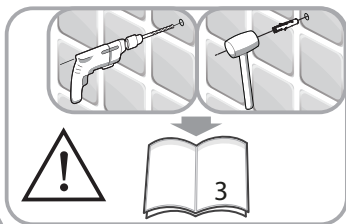
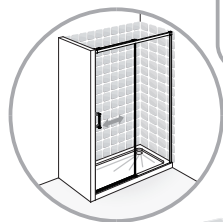

P10



x1

H3



x3

ST 4x40mm

H1



x3



FR Montage

ES Montaje

PT Montagem

IT Montaggio

EL Συναρμολόγηση

PL Montaż

RU Сборка

UK Збірка

RO Montaj

EN Assembly

B

5

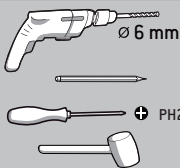
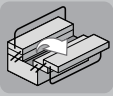
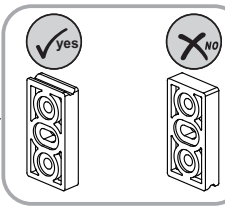
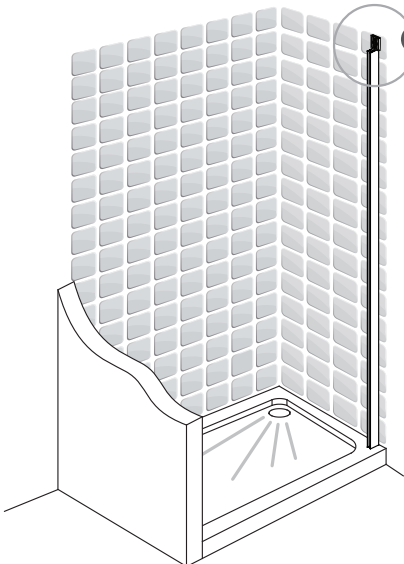
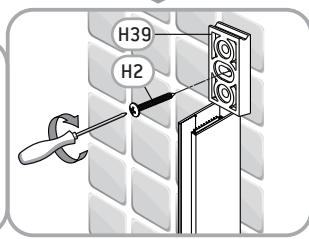
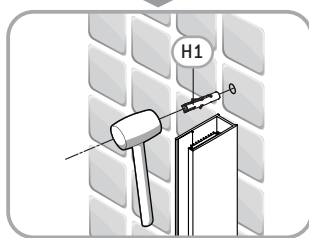
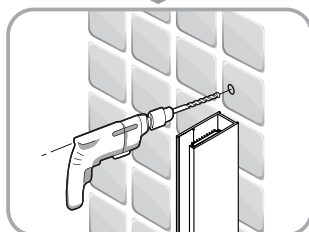
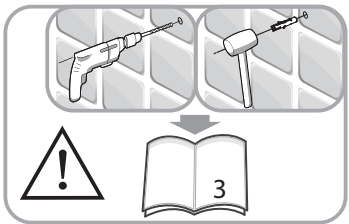
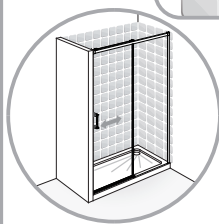
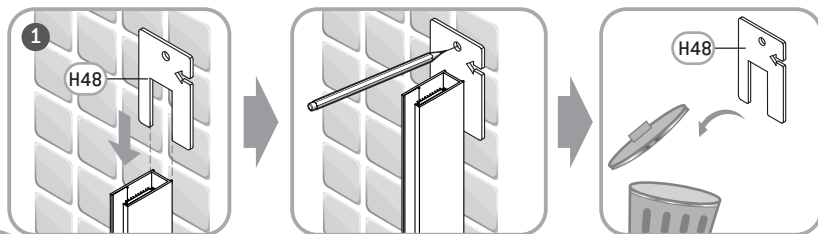

H1  x1

H2  x1
ST 4x40mm

H39  x1

H48  x1



B

FR Montage

ES Montaje

PT Montagem

IT Montaggio

EL Συναρμολόγηση

PL Montaż

RU Сборка

UK Збірка

RO Montaj

EN Assembly

6

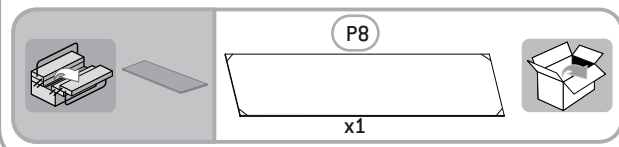
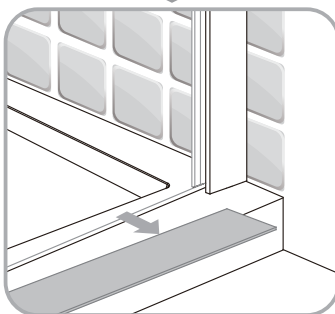
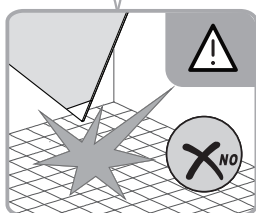
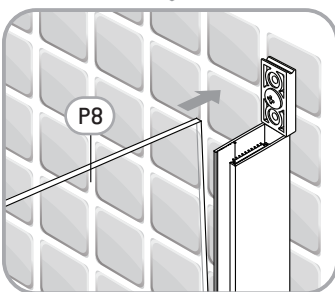
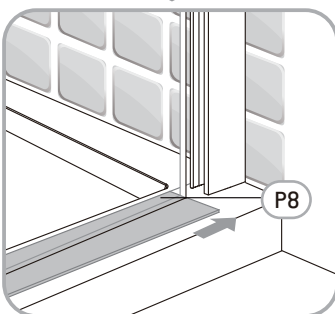
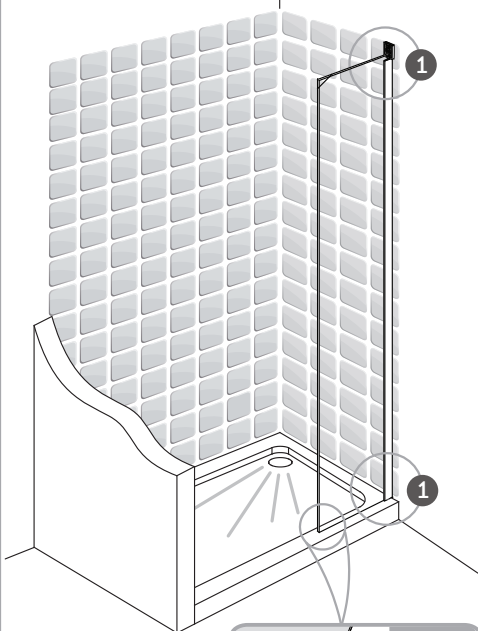
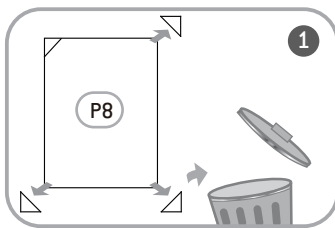
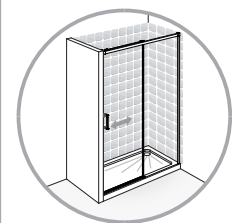

FR Montage

ES Montaje

PT Montagem

IT Montaggio

EL Συναρμολόγηση

PL Montaż

RU Сборка

UK Збірка

RO Montaj

EN Assembly

B

7

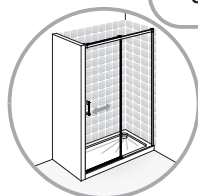
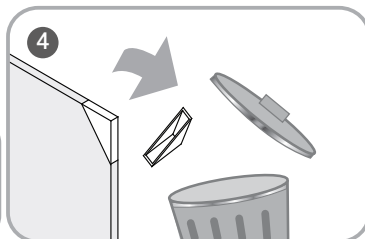
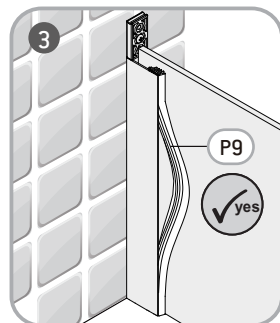
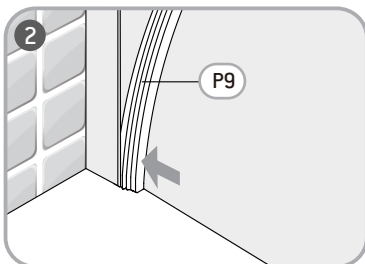
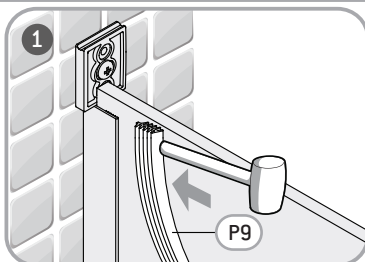
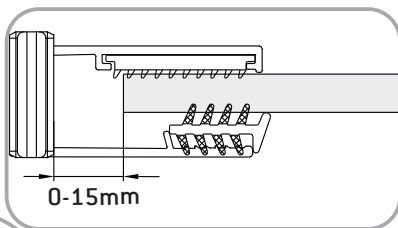

REMIX	L[mm]
1000mm	495 - 510
1100mm	545 - 560
1200mm	595 - 610
1300mm	645 - 660
1400mm	695 - 710
1500mm	745 - 760
1600mm	795 - 810
1700mm	845 - 860
1800mm	895 - 910

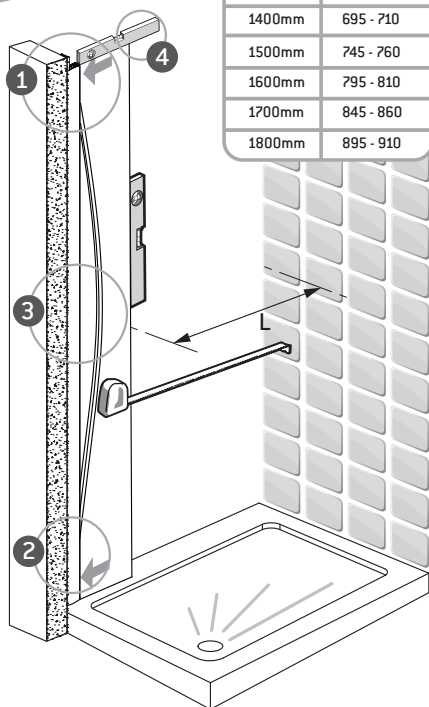

P9



x1



B

FR Montage

ES Montaje

PT Montagem

IT Montaggio

EL Συναρμολόγηση

PL Montaż

RU Сборка

UK Збірка

RO Montaj

EN Assembly

8

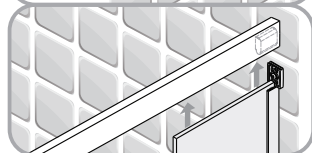
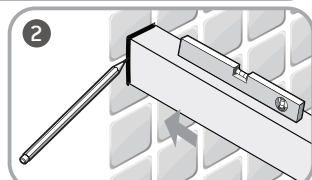
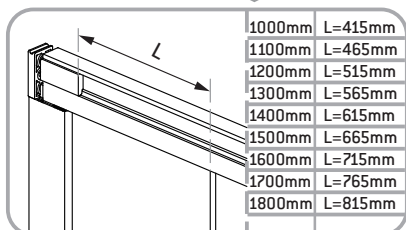
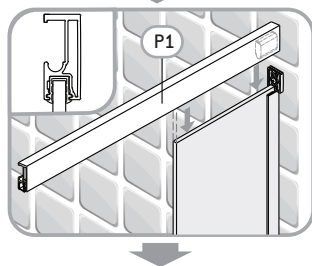
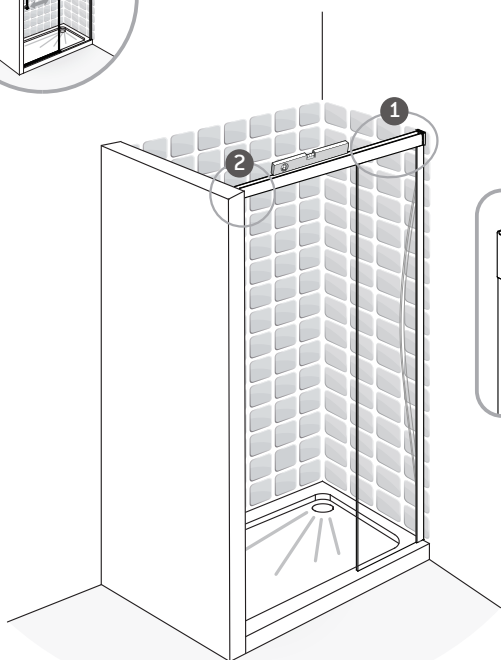
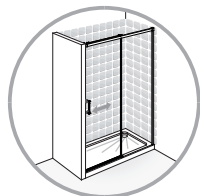
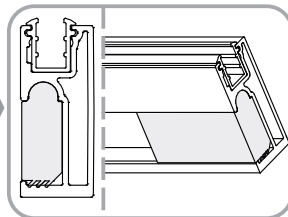
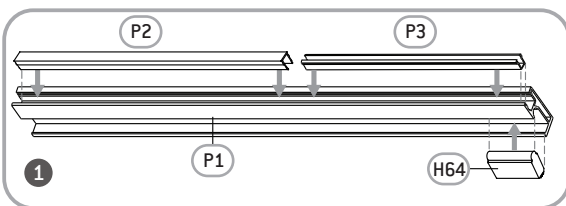

P1



x1

P2

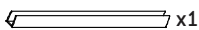

x1

P3

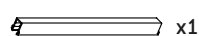

x1

H64



x1



FR Montage

ES Montaje

PT Montagem

IT Montaggio

EL Συναρμολόγηση

PL Montaż

RU Сборка

UK Збірка

RO Montaj

EN Assembly

B

9

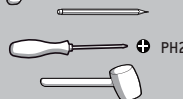
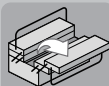
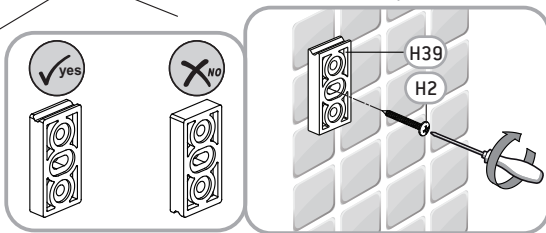
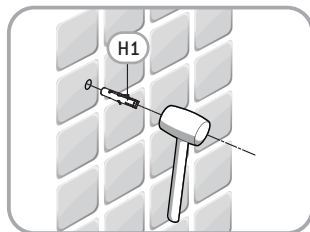
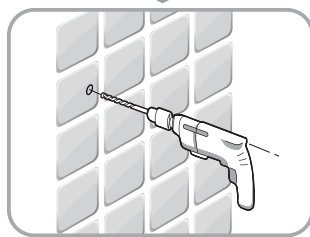
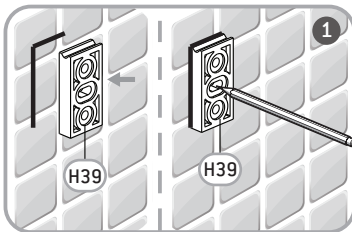
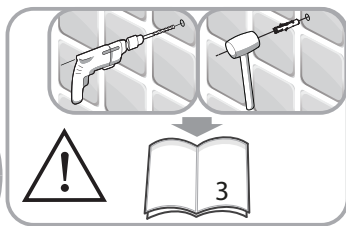
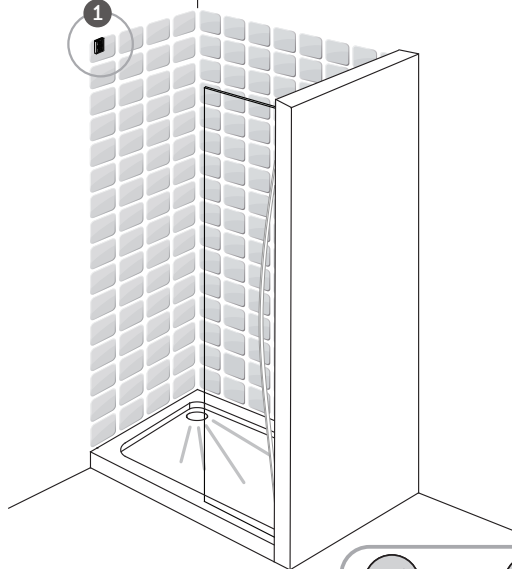
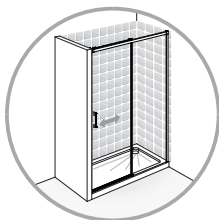

H1  x1

H2  x1
ST 4x40mm

H39  x1



B

FR Montage

ES Montaje

PT Montagem

IT Montaggio

EL Συναρμολόγηση

PL Montaż

RU Сборка

UK Збірка

RO Montaj

EN Assembly

10

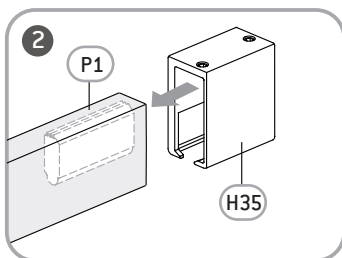
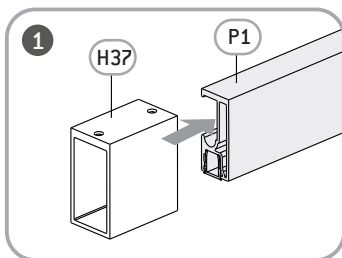
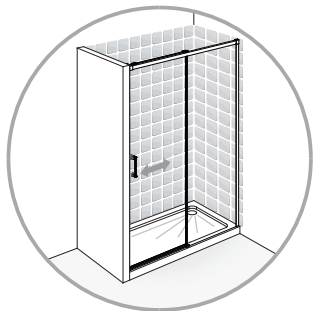

P1



x1

H35



x1

H37



x1

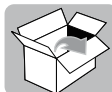

FR Montage

ES Montaje

PT Montagem

IT Montaggio

EL Συναρμολόγηση

PL Montaż

RU Сборка

UK Збірка

RO Montaj

EN Assembly

B

11

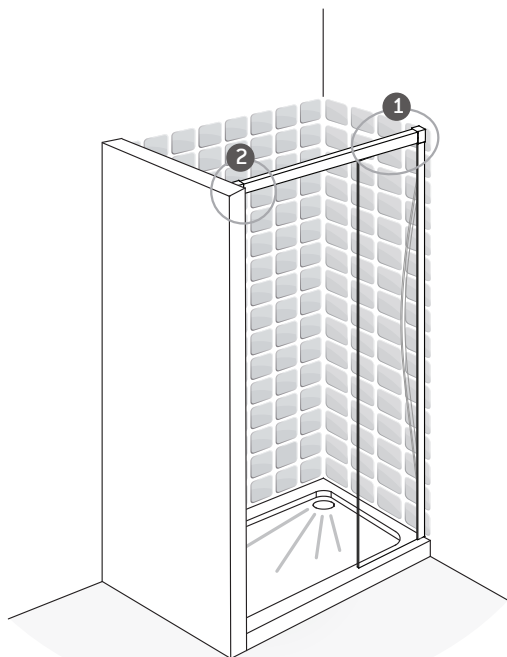
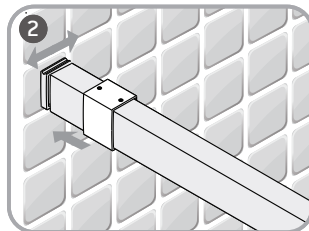
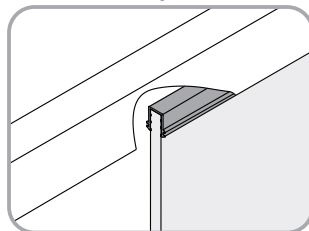
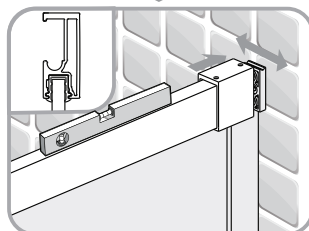
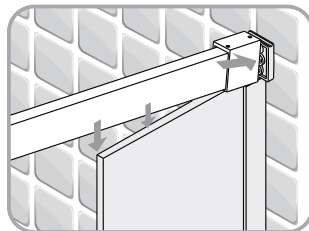
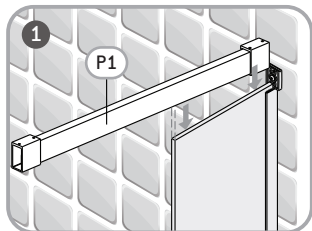

P1

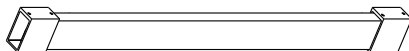

x1



B

FR Montage

ES Montaje

PT Montagem

IT Montaggio

EL Συναρμολόγηση

PL Montaż

RU Сборка

UK Збірка

RO Montaj

EN Assembly

12

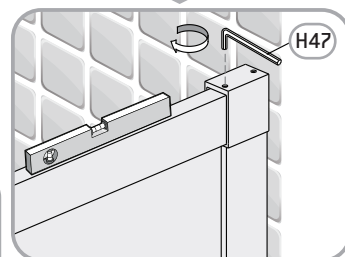
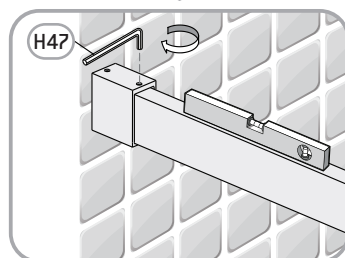
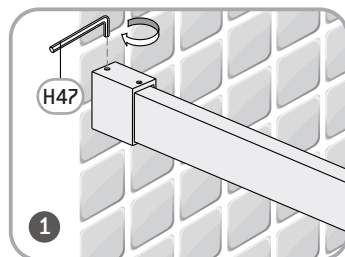
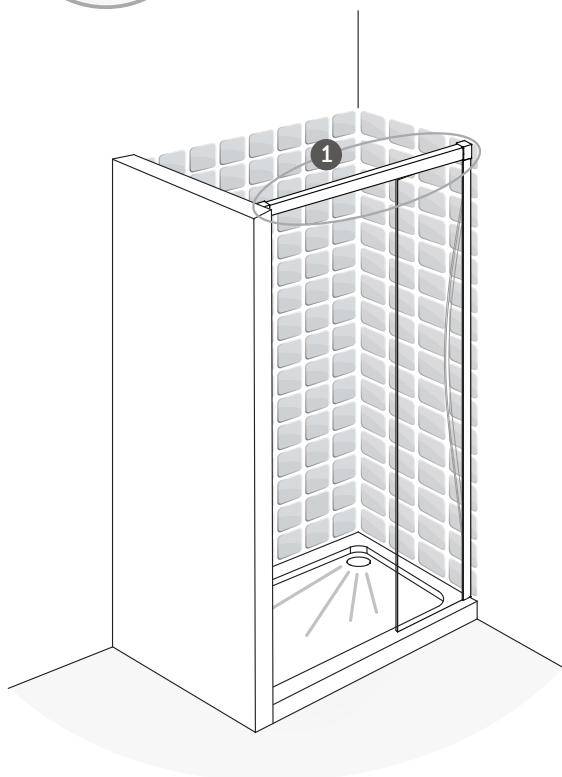

H47



x1

2.5mm



FR Montage

ES Montaje

PT Montagem

IT Montaggio

EL Συναρμολόγηση

PL Montaż

RU Сборка

UK Збірка

RO Montaj

EN Assembly

B

13



⊕ PH2

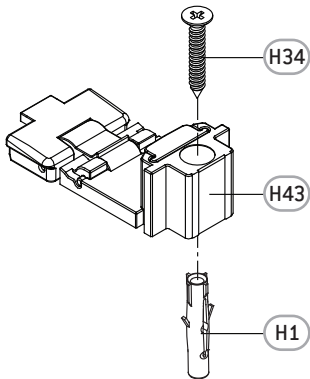

H34

H43

H1

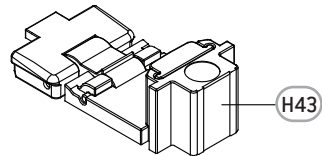
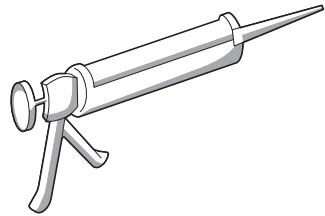

H43

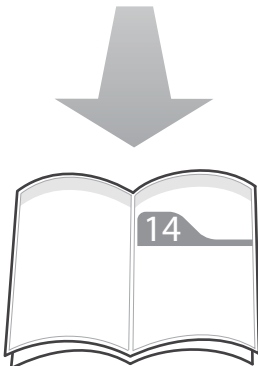

14

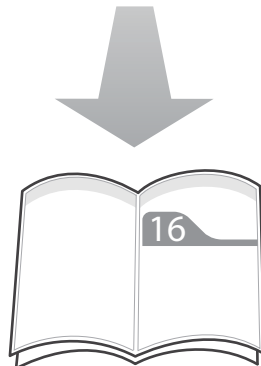

16

B**FR** Montage**ES** Montaje**PT** Montagem**IT** Montaggio**EL** Συναρμολόγηση**PL** Montaż**RU** Сборка**UK** Збірка**RO** Montaj**EN** Assembly

14

FR "Avertissement ! Vérifiez auprès du fabricant du receveur de douche que celui-ci peut être percé. Si ce n'est pas le cas, utilisez du silicone."

ES "¡Advertencia! Consulte con el fabricante del plato de la ducha si puede ser perforado. Utilice silicona en caso contrario."

PT "Aviso! Pergunte ao fabricante da base de chuveiro se esta pode ser perfurada. Se não for o caso, use silicone."

IT "Verificare con il produttore della colonna per la doccia se quest'ultima può essere forata. In caso contrario, utilizzare del silicone."

EL "Προειδοποίηση! Ρωτήστε τον κατασκευαστή ντουζιέρας εάν μπορεί να βιδωθεί. Εάν δεν γίνεται, χρησιμοποιήστε σιλικόνη."

PL "Ostrzeżenie! Prosimy sprawdzić u producenta brodzika, czy można w nim wierceć otwory. Jeżeli nie, należy użyć silikonu."

RU "Предупреждение! Узнайте у производителя душевого поддона, допускается ли его сверление. В противном случае используйте силиконовый герметик."

UK "Увага! Зверніться до виробника душевого піддона щодо питання свердлення піддона. Якщо це неможливо, використовуйте силікон."

RO "Avertizare! Consultați-vă cu producătorul cădăței de duș pentru a afla dacă această poate fi găurită. Dacă nu poate fi găurită, utilizați silicon."

EN "Warning! Check with shower tray's maker if it can be drilled. If not, use silicon."

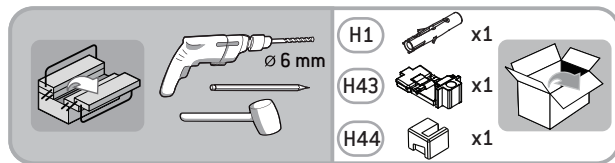
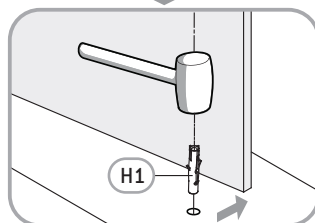
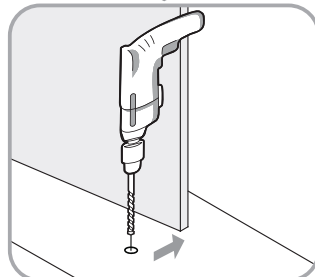
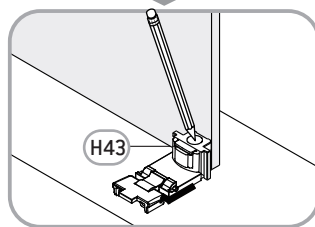
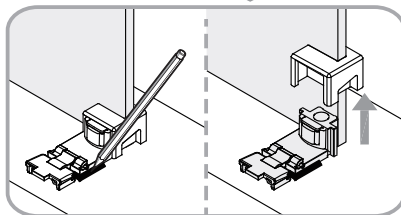
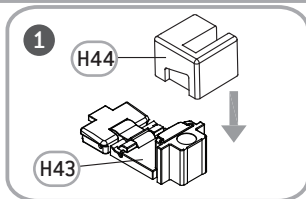
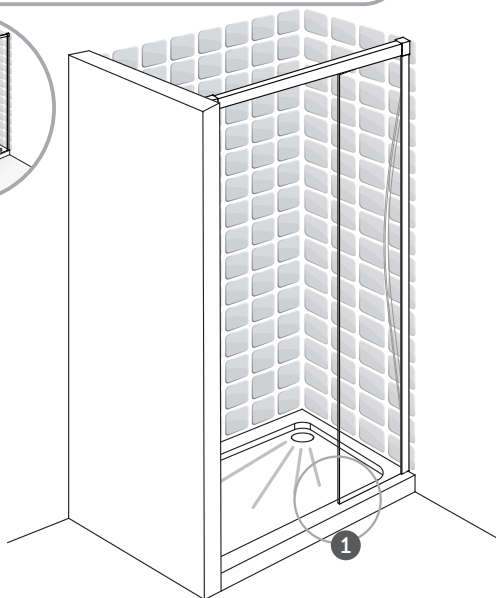
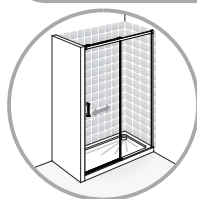

FR Montage

ES Montaje

PT Montagem

IT Montaggio

EL Συναρμολόγηση

PL Montaż

RU Сборка

UK Збірка

RO Montaj

EN Assembly

B

15

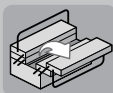
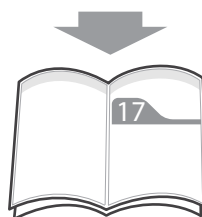
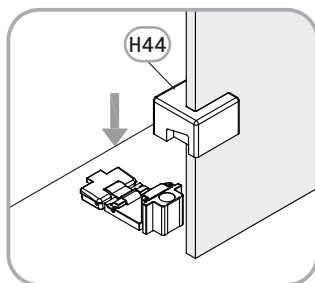
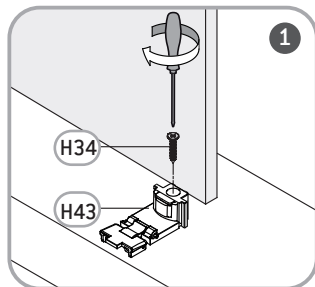
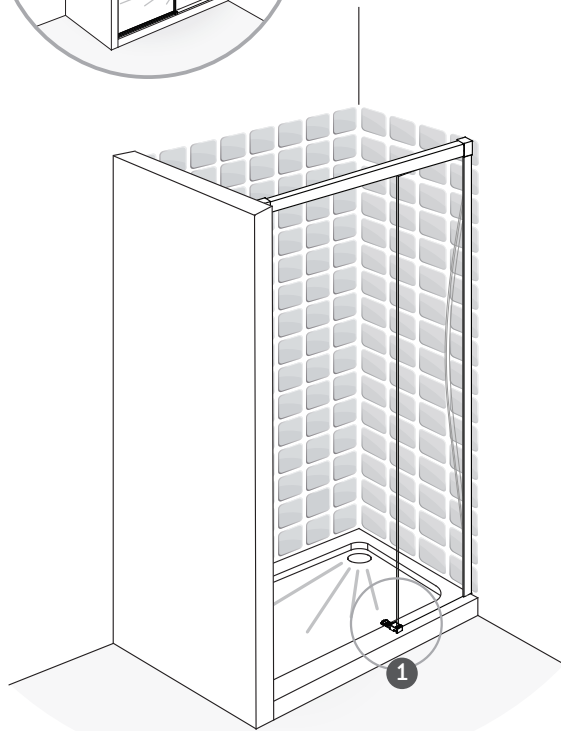

PH2

H34



x1

ST 4x30mm

H43



x1

H44



x1



B

FR Montage

ES Montaje

PT Montagem

IT Montaggio

EL Συναρμολόγηση

PL Montaż

RU Сборка

UK Збірка

RO Montaj

EN Assembly

16

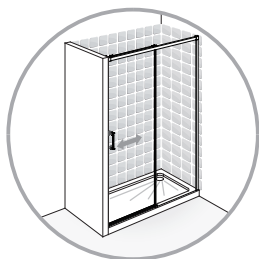

1

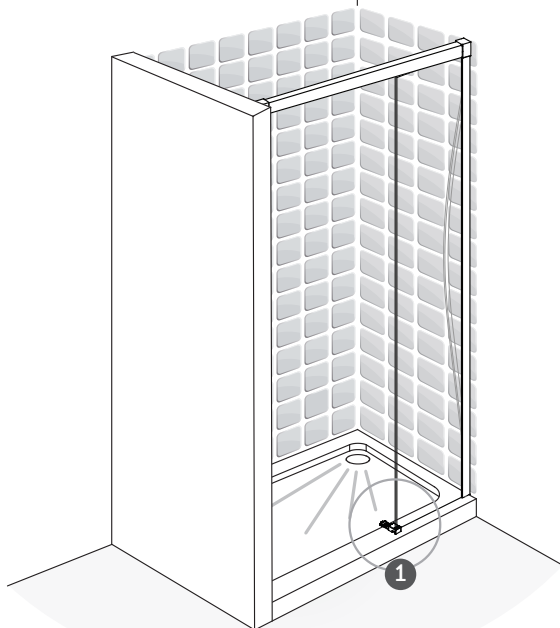
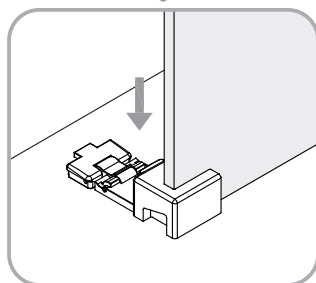
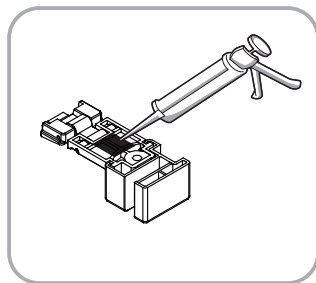
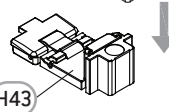
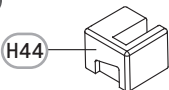

1

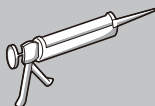
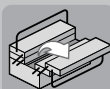

H43

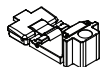

x1

H44



x1



FR Montage

ES Montaje

PT Montagem

IT Montaggio

EL Συναρμολόγηση

PL Montaż

RU Сборка

UK Збірка

RO Montaj

EN Assembly

B

17

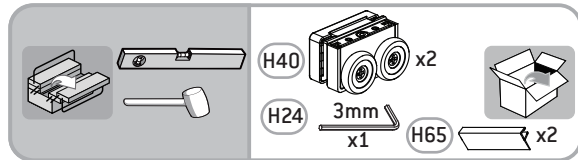
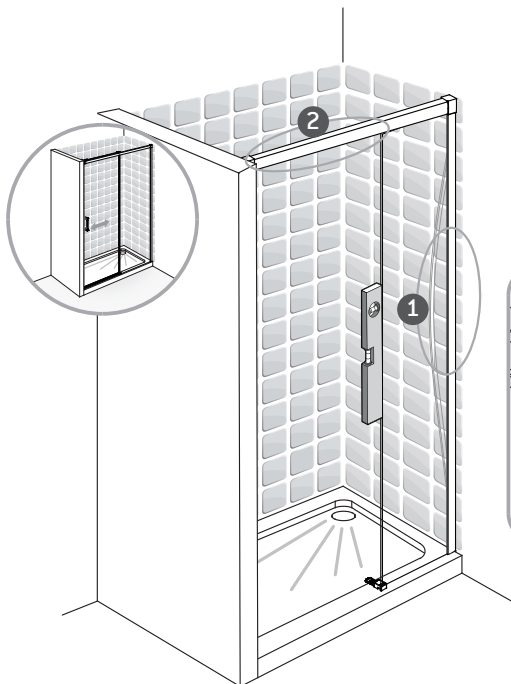
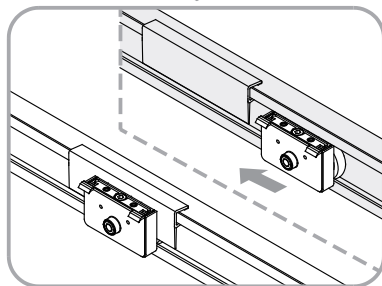
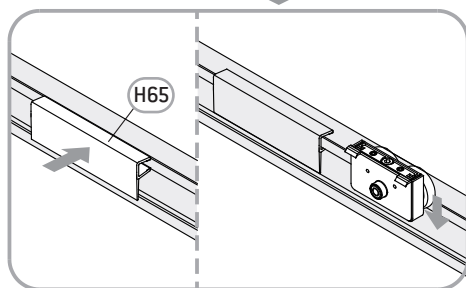
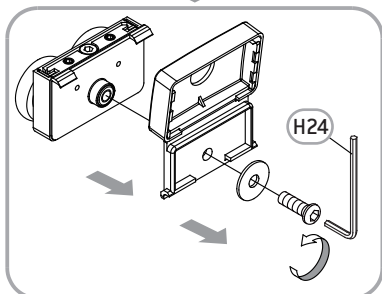
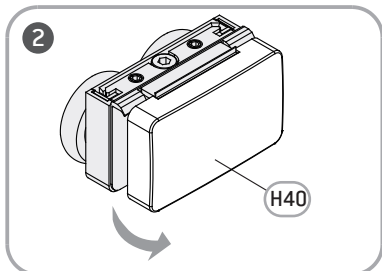
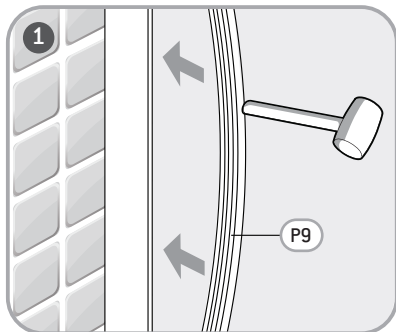

B

FR Montage

ES Montaje

PT Montagem

IT Montaggio

EL Συναρμολόγηση

PL Montaż

RU Сборка

UK Збірка

RO Montaj

EN Assembly

18

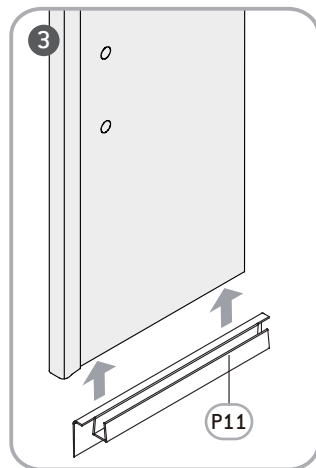
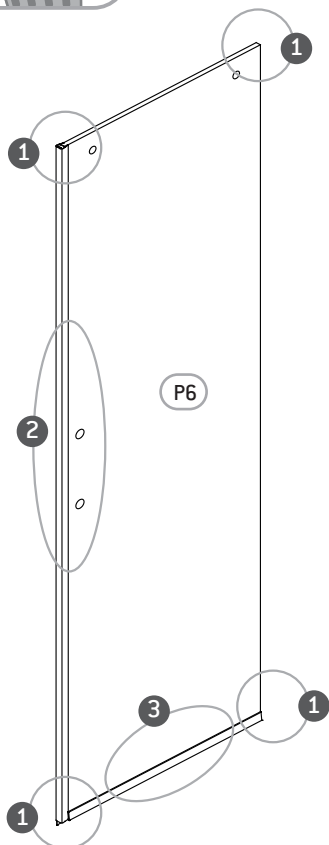
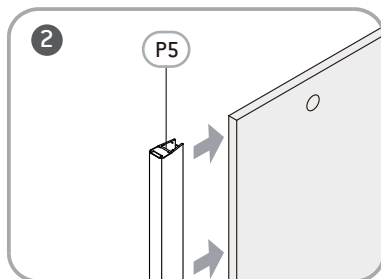
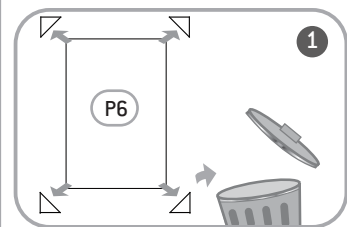
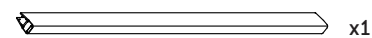
P11  x1P6  x1P5  x1

FR Montage

ES Montaje

PT Montagem

IT Montaggio

EL Συναρμολόγηση

PL Montaż

RU Сборка

UK Збірка

RO Montaj

EN Assembly

B

19

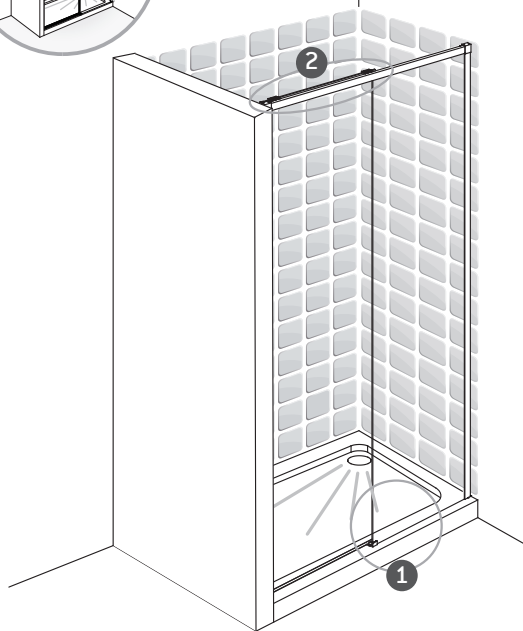
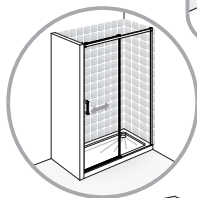
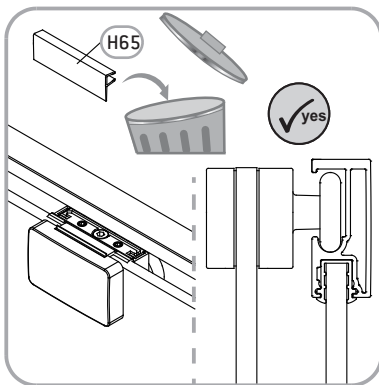
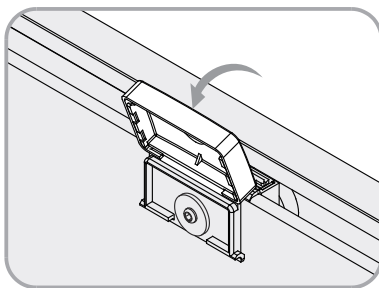
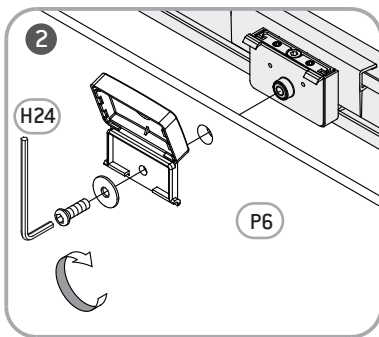
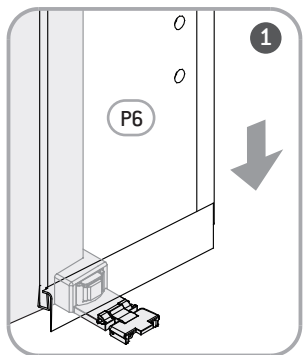

H24

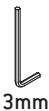

x1



B

FR Montage

ES Montaje

PT Montagem

IT Montaggio

EL Συναρμολόγηση

PL Montaż

RU Сборка

UK Збірка

RO Montaj

EN Assembly

20

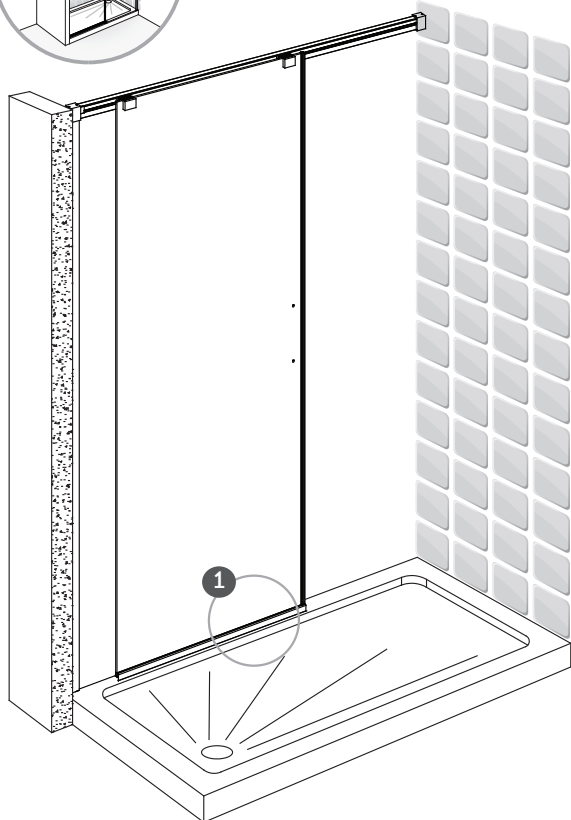
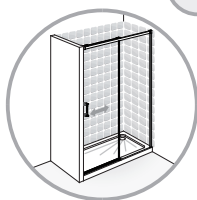
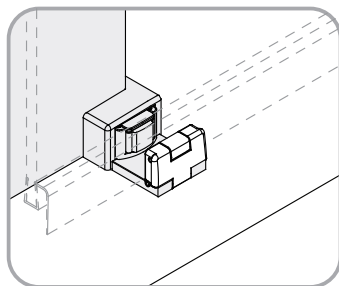
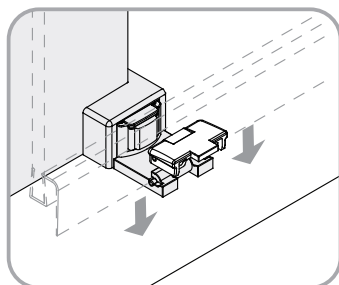
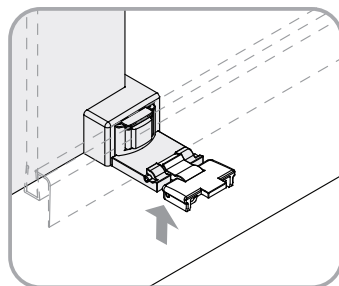
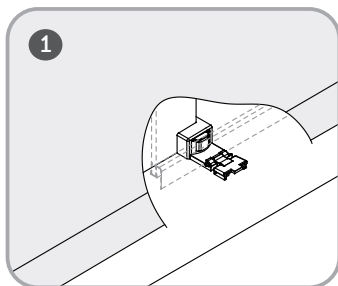

FR Montage

ES Montaje

PT Montagem

IT Montaggio

EL Συναρμολόγηση

PL Montaż

RU Сборка

UK Збірка

RO Montaj

EN Assembly

B

21

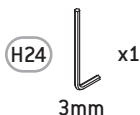
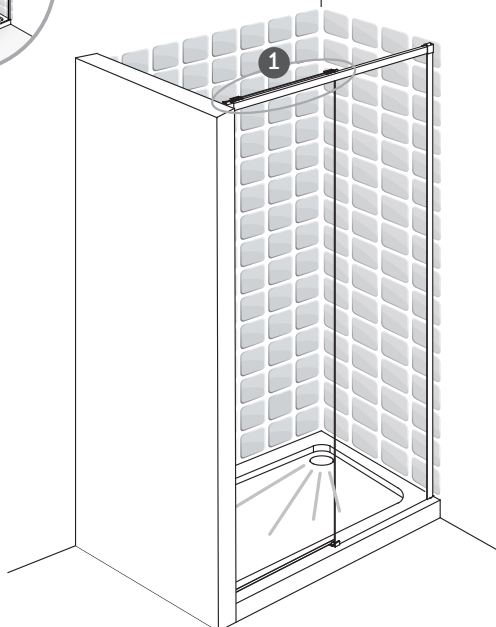
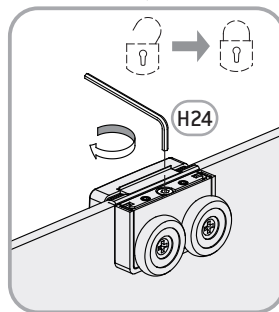
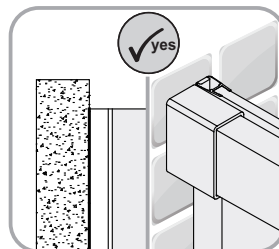
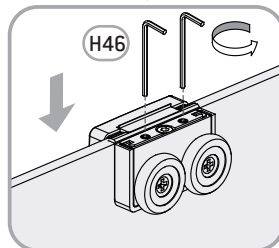
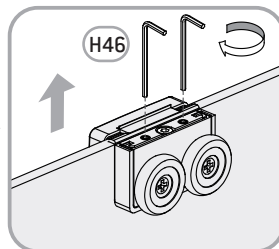
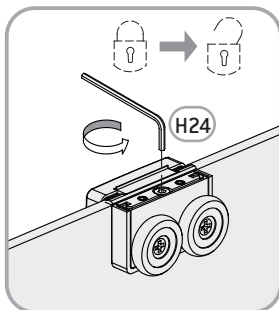
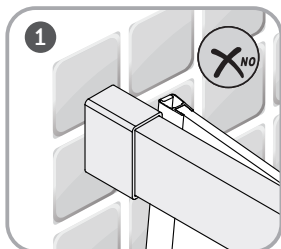

B

FR Montage

ES Montaje

PT Montagem

IT Montaggio

EL Συναρμολόγηση

PL Montaż

RU Сборка

UK Збірка

RO Montaj

EN Assembly

22

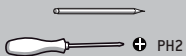
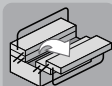
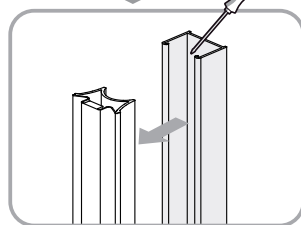
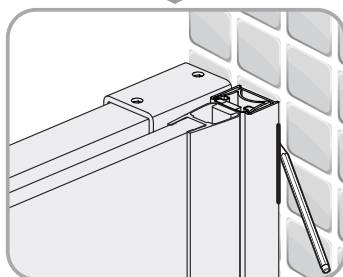
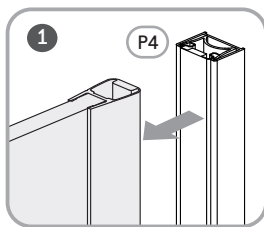
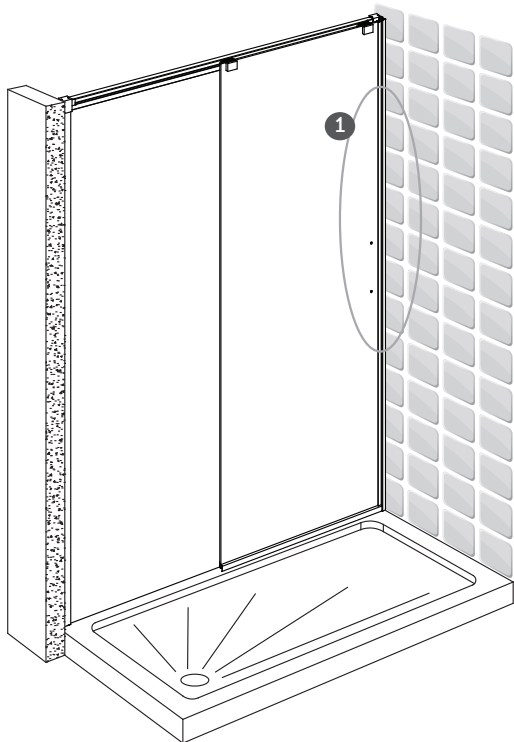

P4

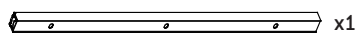

FR Montage

ES Montaje

PT Montagem

IT Montaggio

EL Συναρμολόγηση

PL Montaż

RU Сборка

UK Збірка

RO Montaj

EN Assembly

B

23

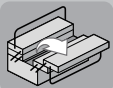
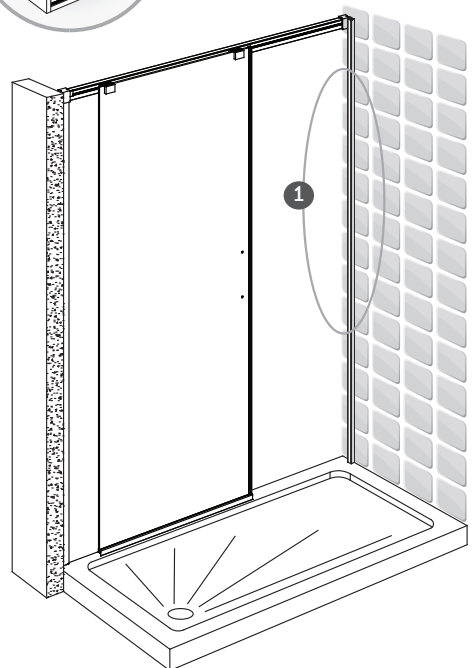
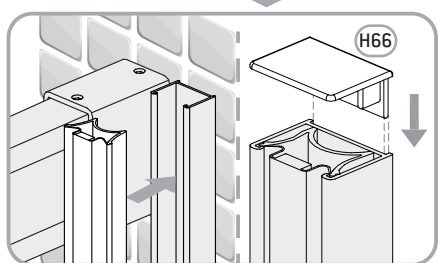
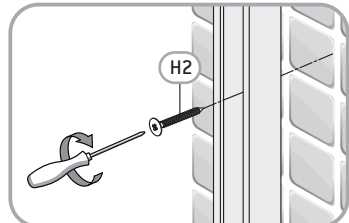
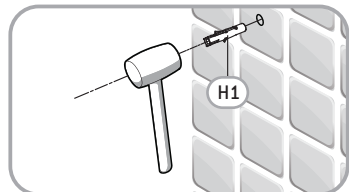
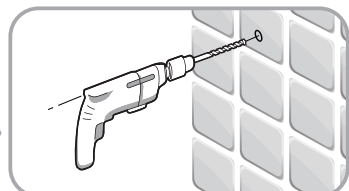
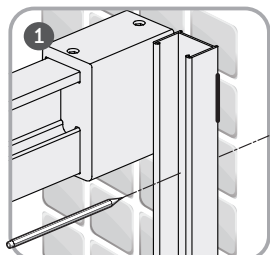
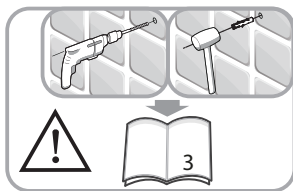

$\varnothing 6 \text{ mm}$
 PH2

(H1) x3 (H2) x3 (H66) x1
 ST 4x40mm

x1
 x1



B

FR Montage

ES Montaje

PT Montagem

IT Montaggio

EL Συναρμολόγηση

PL Montaż

RU Сборка

UK Збірка

RO Montaj

EN Assembly

24

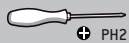
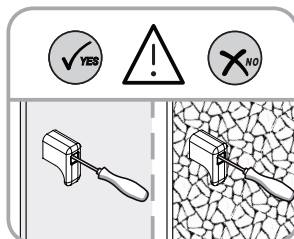
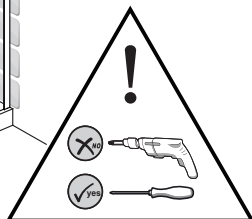
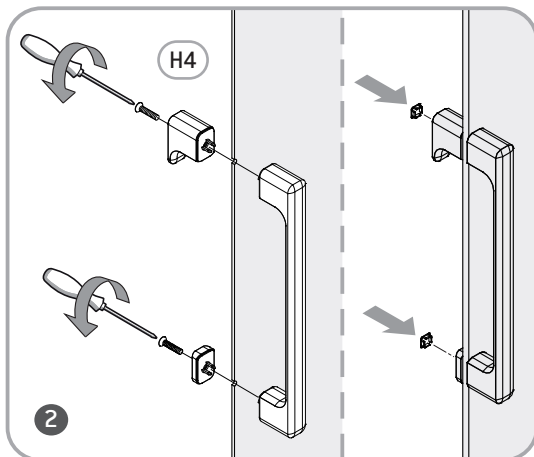
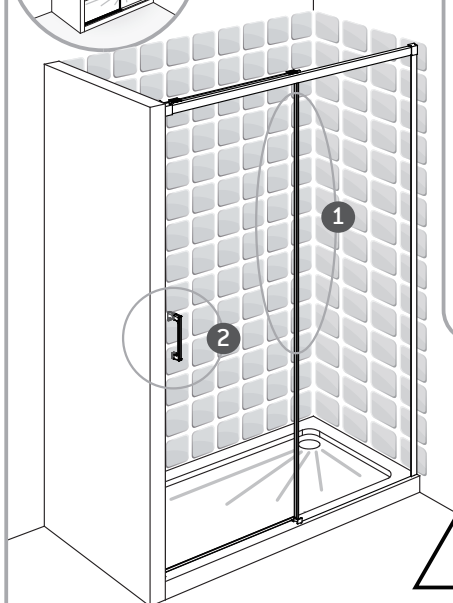
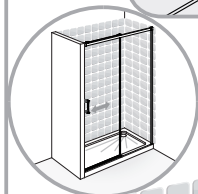
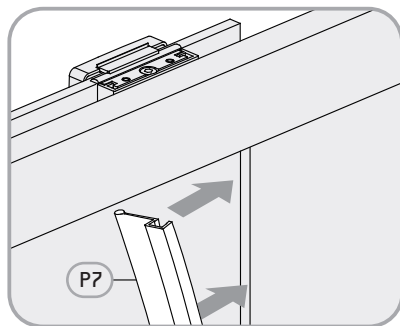
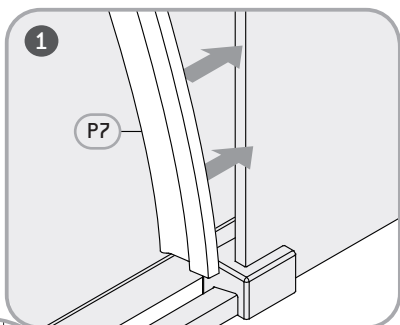
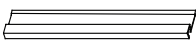
H4  x1P7  x1

FR Montage

ES Montaje

PT Montagem

IT Montaggio

EL Συναρμολόγηση

PL Montaż

RU Сборка

UK Збірка

RO Montaj

EN Assembly

B

25

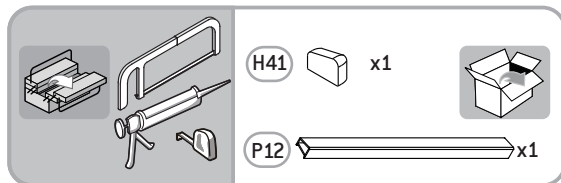
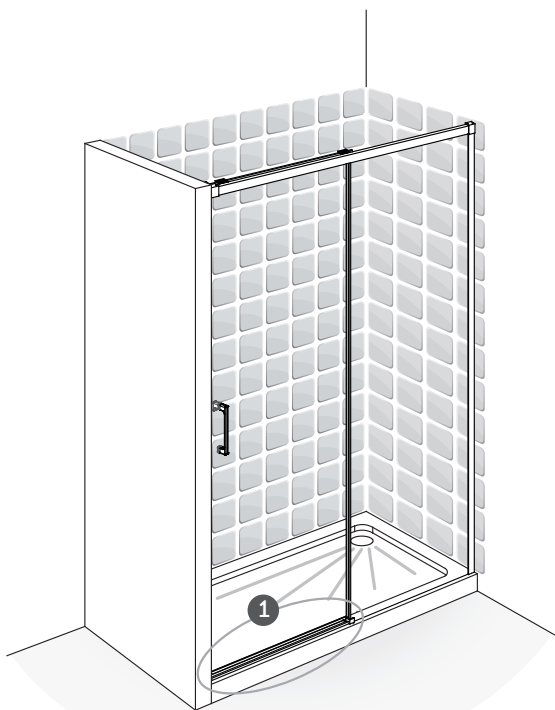
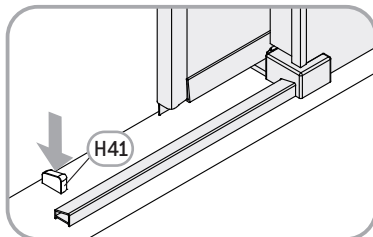
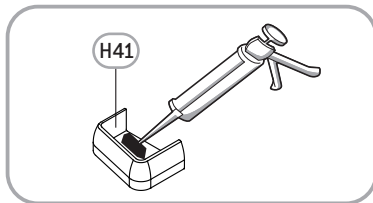
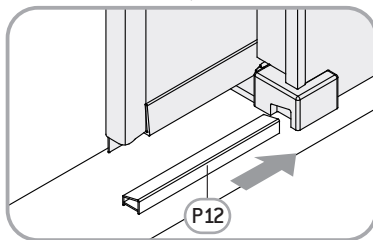
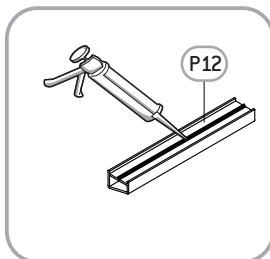
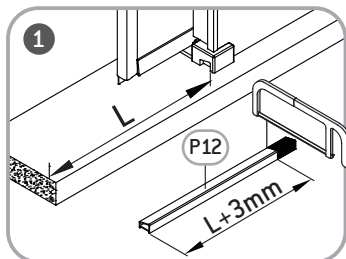
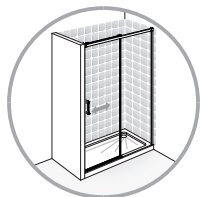

B

FR Montage

ES Montaje

PT Montagem

IT Montaggio

EL Συναρμολόγηση

PL Montaż

RU Сборка

UK Збірка

RO Montaj

EN Assembly

26

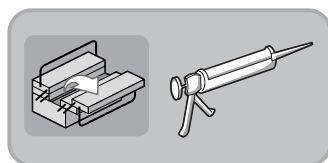
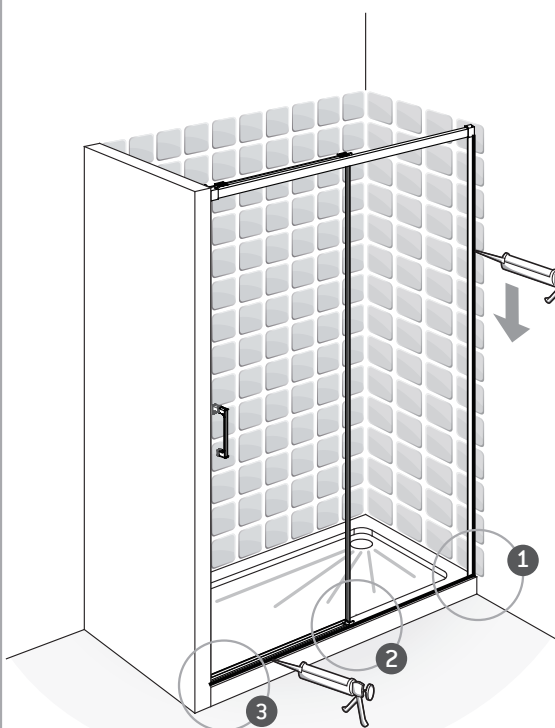
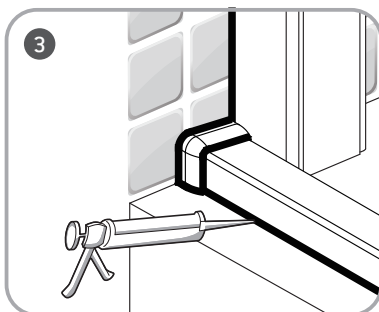
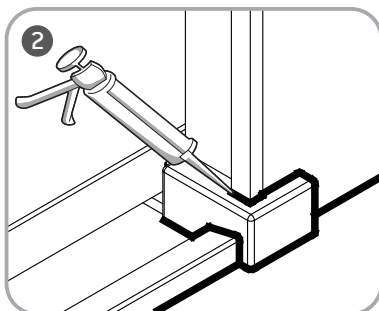
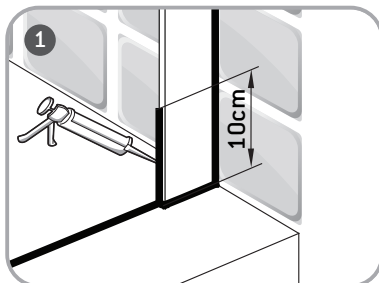
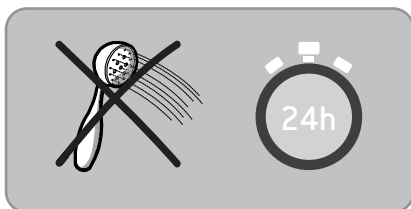
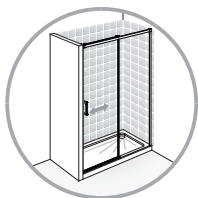

FR Montage

ES Montaje

PT Montagem

IT Montaggio

EL Συναρμολόγηση

PL Montaż

RU Сборка

UK Збірка

RO Montaj

EN Assembly

B

27

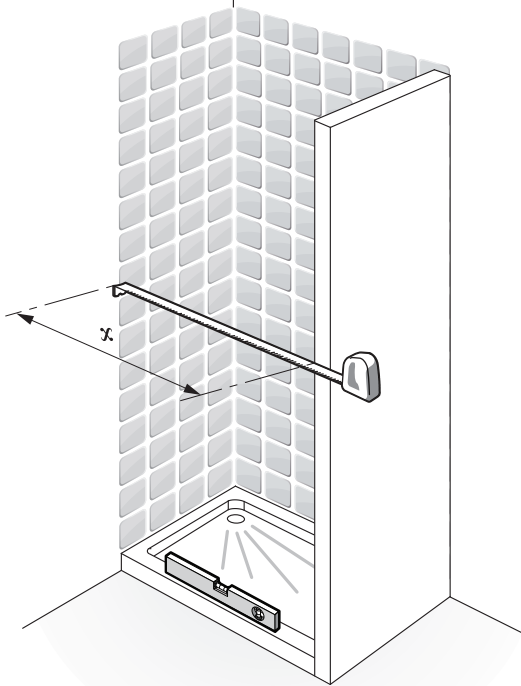

REMIX	X(mm)
1000mm	970 - 1000
1100mm	1070 - 1100
1200mm	1170 - 1200
1300mm	1270 - 1300
1400mm	1370 - 1400
1500mm	1470 - 1500
1600mm	1570 - 1600
1700mm	1670 - 1700
1800mm	1770 - 1800

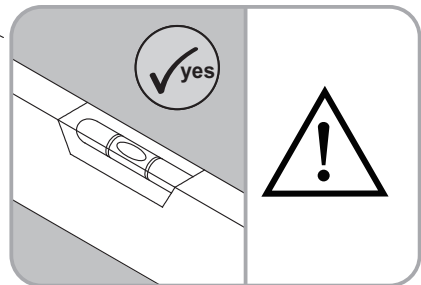
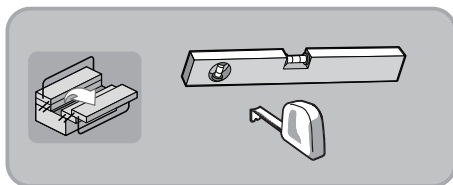

B

FR Montage

ES Montaje

PT Montagem

IT Montaggio

EL Συναρμολόγηση

PL Montaż

RU Сборка

UK Збірка

RO Montaj

EN Assembly

28

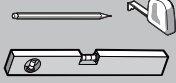
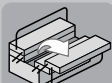
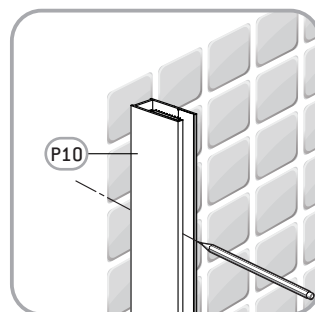
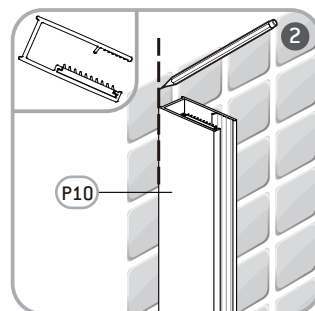
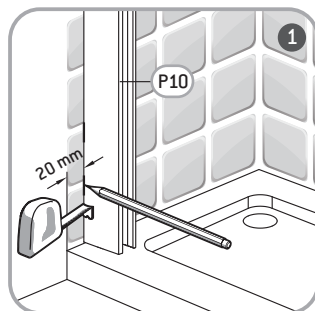
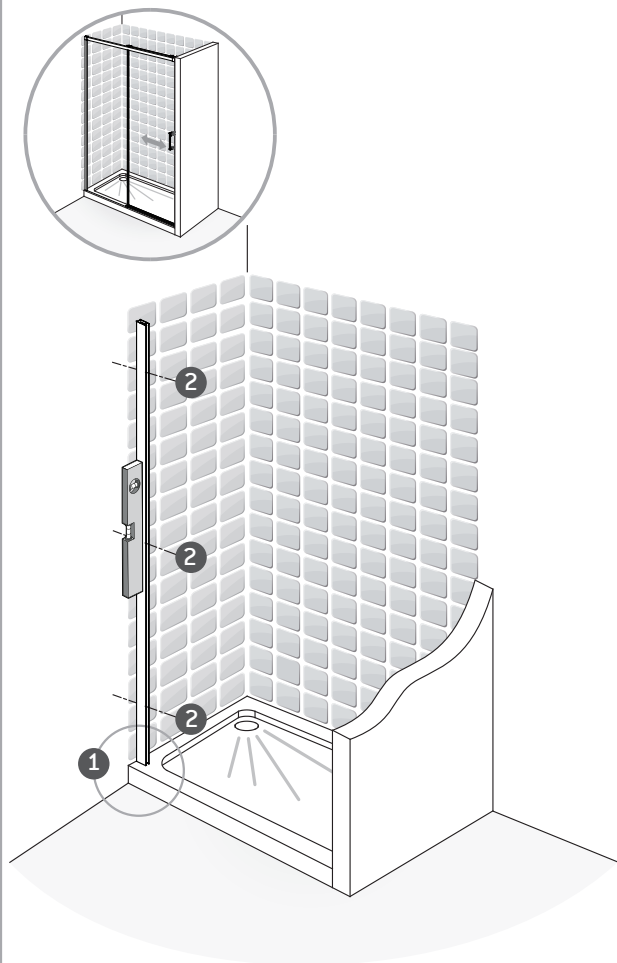

P10



x1



FR Montage

ES Montaje

PT Montagem

IT Montaggio

EL Συναρμολόγηση

PL Montaż

RU Сборка

UK Збірка

RO Montaj

EN Assembly

B

29

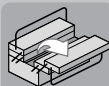
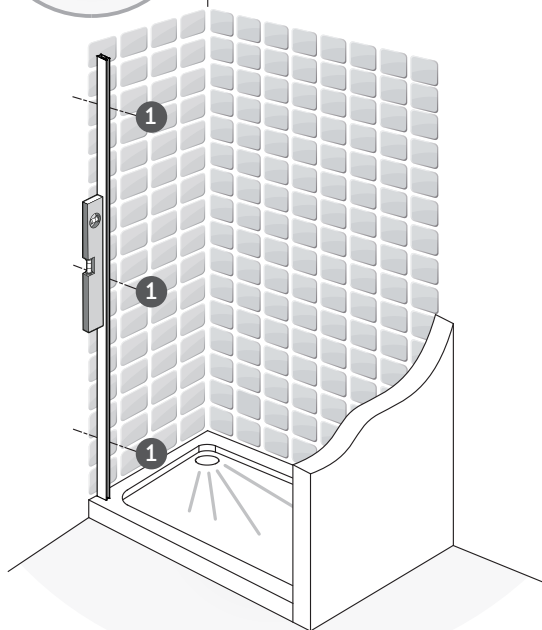
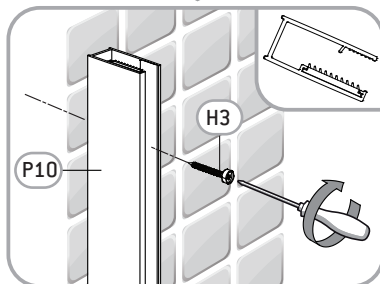
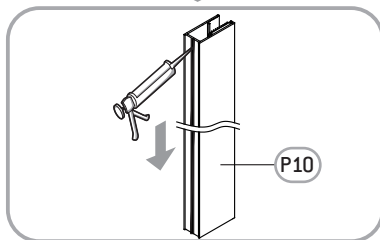
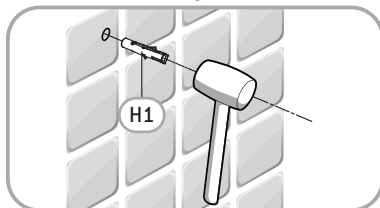
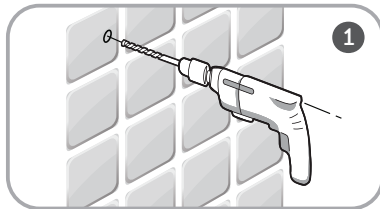
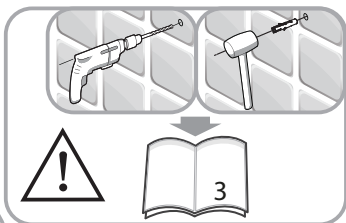
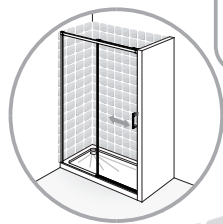

Ø 6 mm

PH2

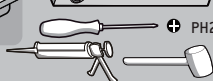

P10



x1

H3



x3

ST 4x40mm

H1



x3



B

FR Montage

ES Montaje

PT Montagem

IT Montaggio

EL Συναρμολόγηση

PL Montaż

RU Сборка

UK Збірка

RO Montaj

EN Assembly

30

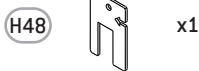
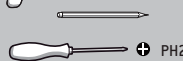
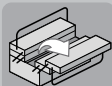
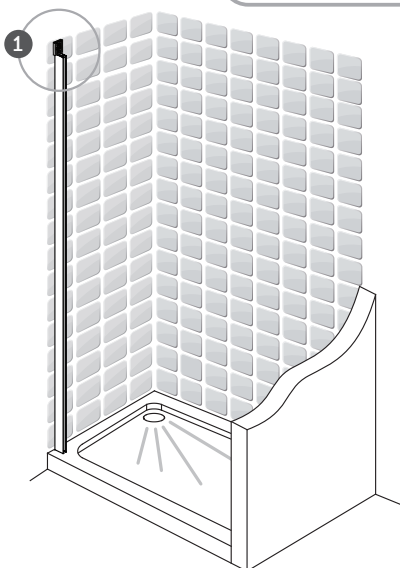
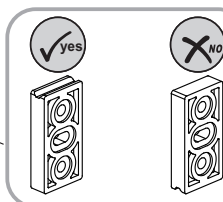
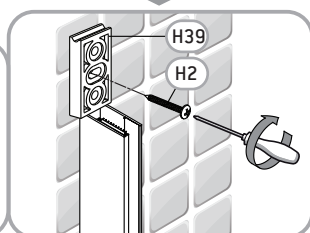
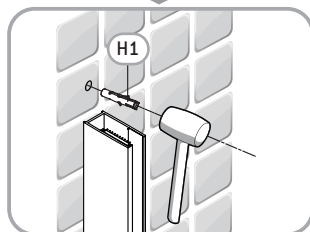
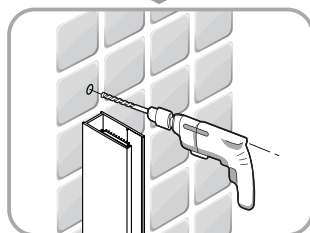
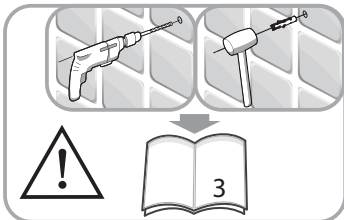
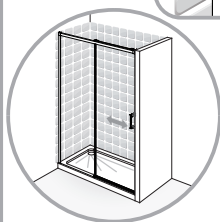
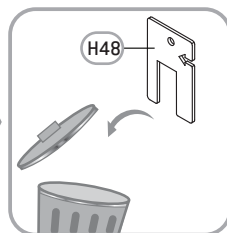
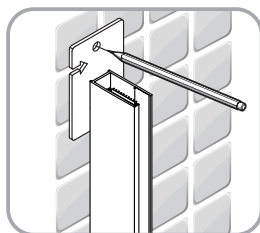
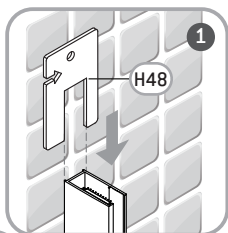

FR Montage

ES Montaje

PT Montagem

IT Montaggio

EL Συναρμολόγηση

PL Montaż

RU Сборка

UK Збірка

RO Montaj

EN Assembly

B

31

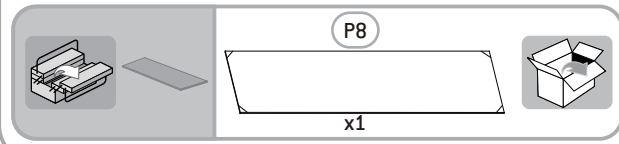
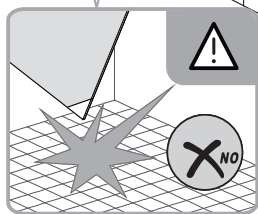
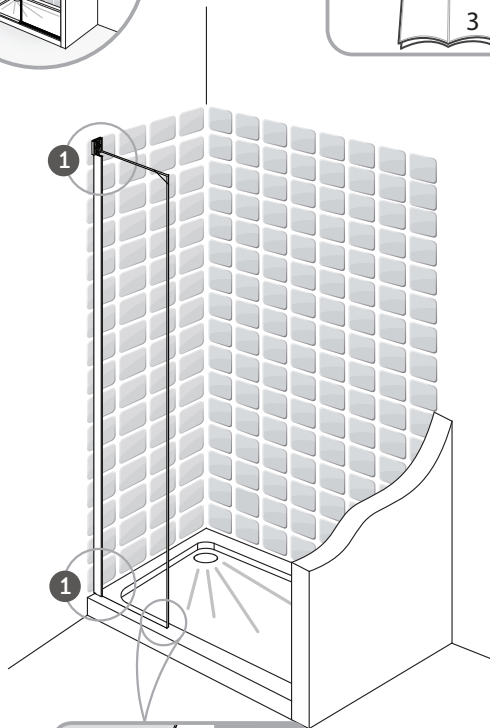
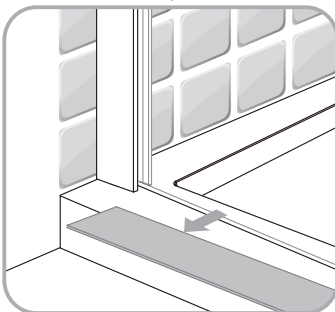
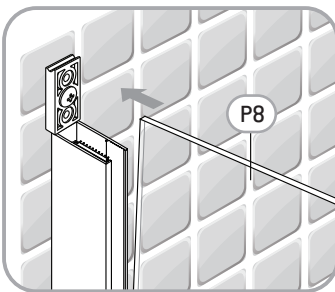
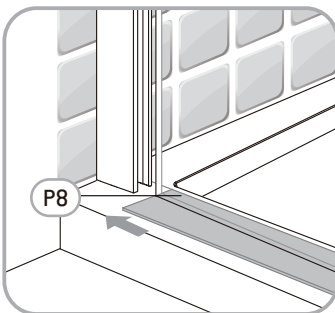
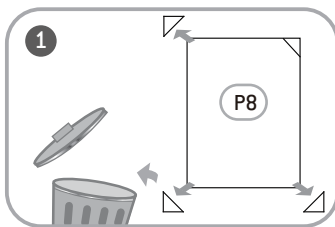
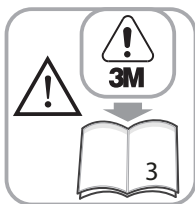
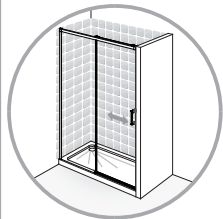

B

FR Montage

ES Montaje

PT Montagem

IT Montaggio

EL Συναρμολόγηση

PL Montaż

RU Сборка

UK Збірка

RO Montaj

EN Assembly

32

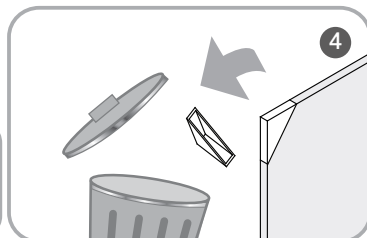
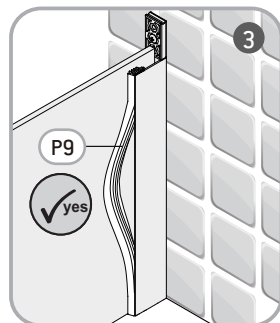
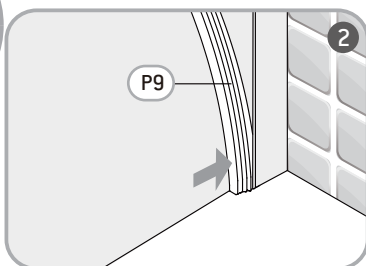
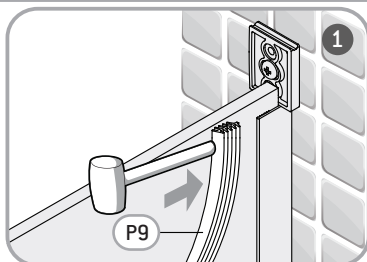
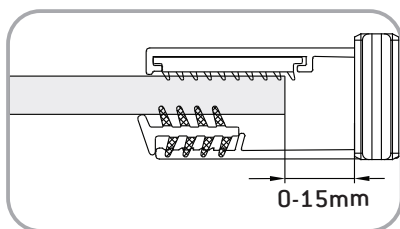

REMIX	L(mm)
1000mm	495 - 510
1100mm	545 - 560
1200mm	595 - 610
1300mm	645 - 660
1400mm	695 - 710
1500mm	745 - 760
1600mm	795 - 810
1700mm	845 - 860
1800mm	895 - 910

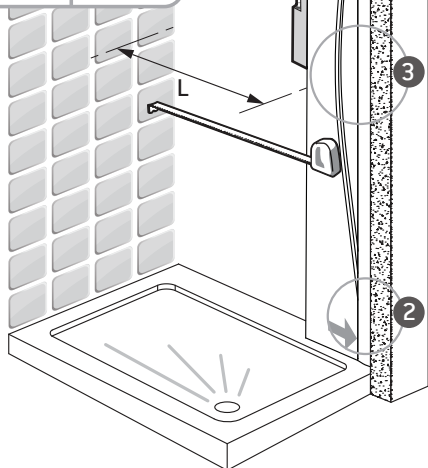

P9



x1



FR Montage

ES Montaje

PT Montagem

IT Montaggio

EL Συναρμολόγηση

PL Montaż

RU Сборка

UK Збірка

RO Montaj

EN Assembly

B

33

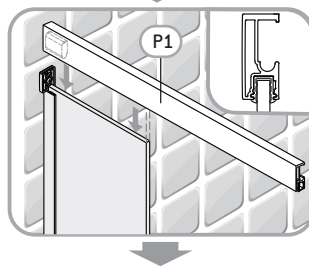
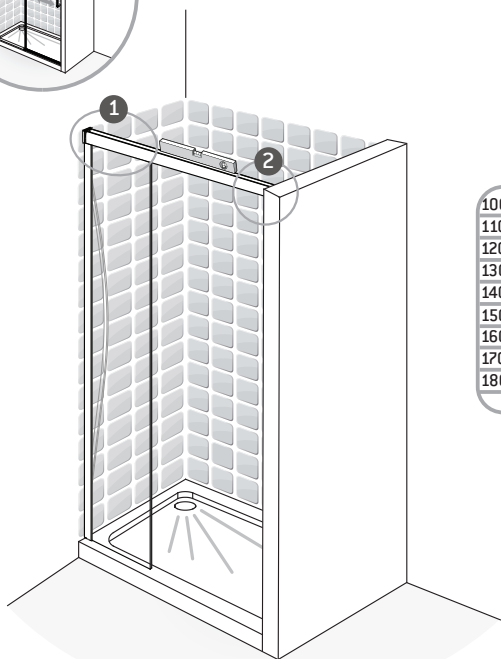
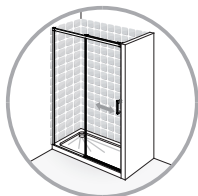
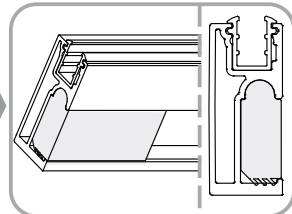
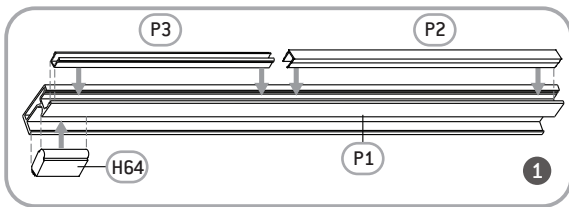

1000mm	L=415mm
1100mm	L=465mm
1200mm	L=515mm
1300mm	L=565mm
1400mm	L=615mm
1500mm	L=665mm
1600mm	L=715mm
1700mm	L=765mm
1800mm	L=815mm

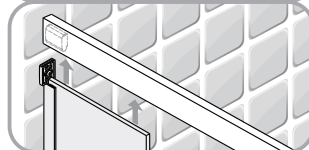
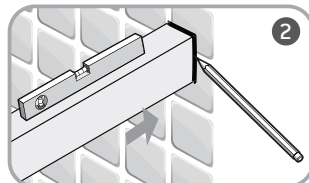

P1



x1

P2



x1

P3



x1

H64



x1



B

FR Montage

ES Montaje

PT Montagem

IT Montaggio

EL Συναρμολόγηση

PL Montaż

RU Сборка

UK Збірка

RO Montaj

EN Assembly

34

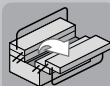
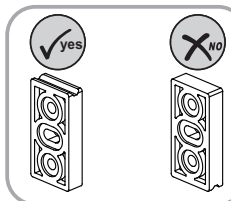
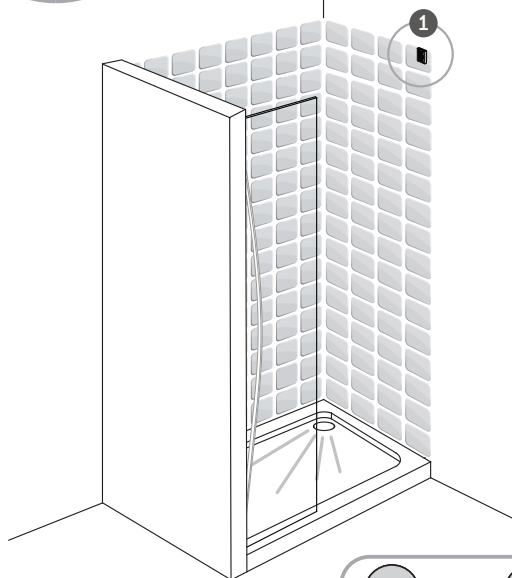
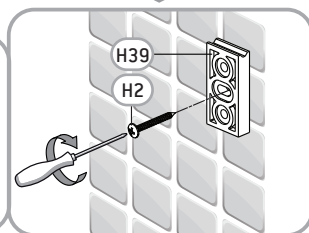
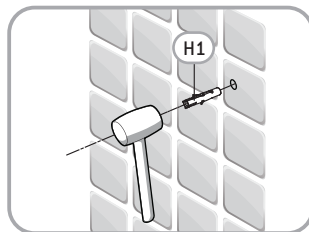
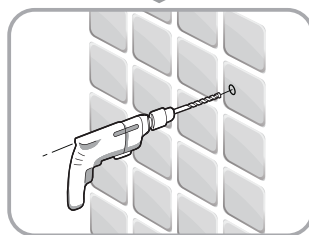
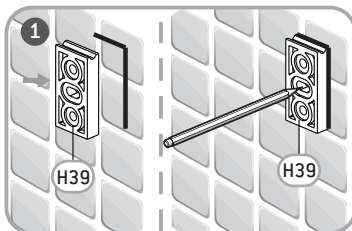
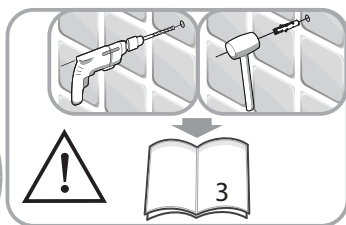
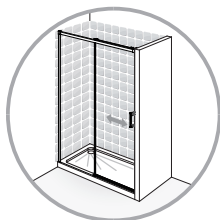

ST 4x40mm



FR Montage

ES Montaje

PT Montagem

IT Montaggio

EL Συναρμολόγηση

PL Montaż

RU Сборка

UK Збірка

RO Montaj

EN Assembly

B

35

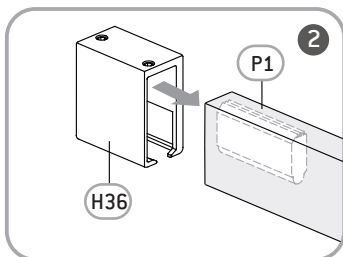
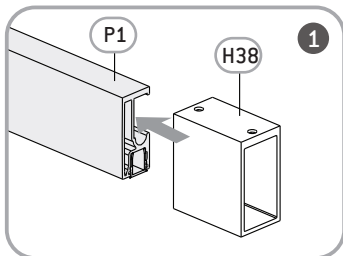

P1



x1

H36



x1

H38



x1



B

FR Montage

ES Montaje

PT Montagem

IT Montaggio

EL Συναρμολόγηση

PL Montaż

RU Сборка

UK Збірка

RO Montaj

EN Assembly

36

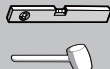
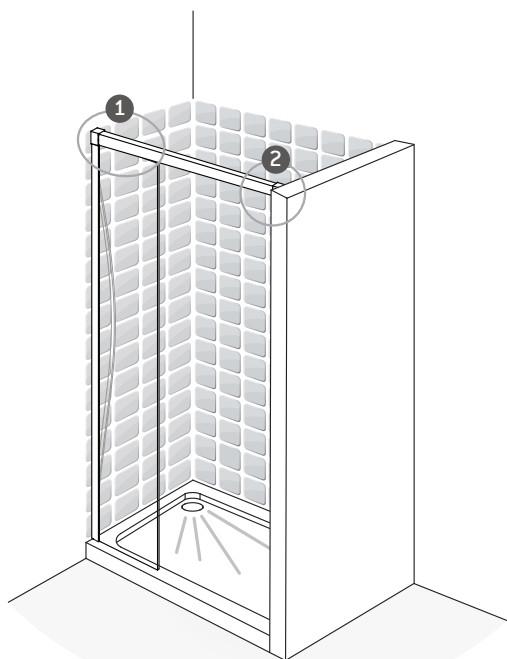
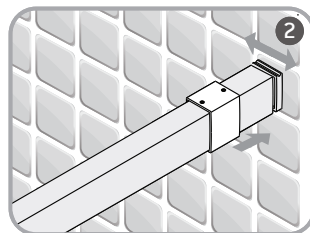
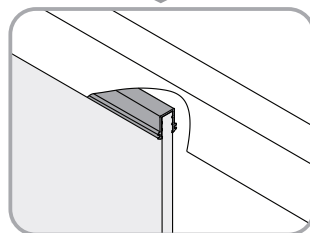
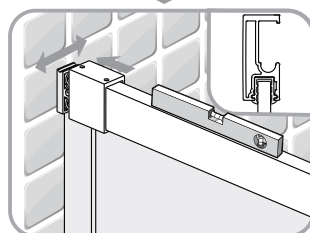
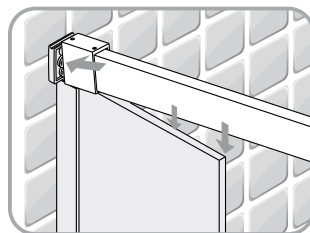
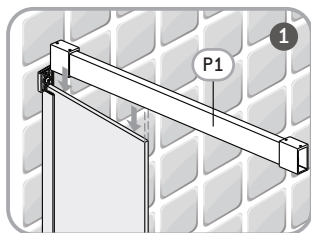

P1

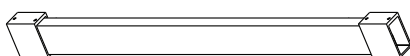

x1



FR Montage

ES Montaje

PT Montagem

IT Montaggio

EL Συναρμολόγηση

PL Montaż

RU Сборка

UK Збірка

RO Montaj

EN Assembly

B

37

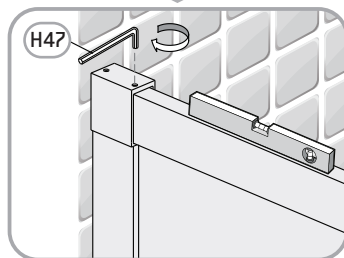
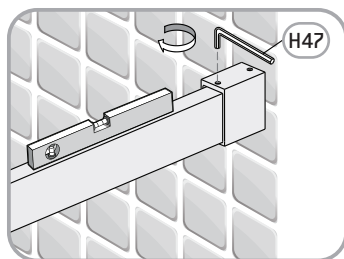
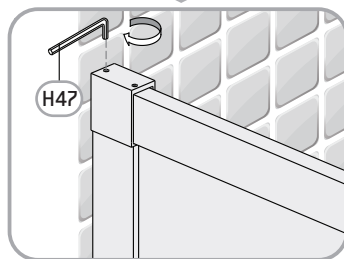
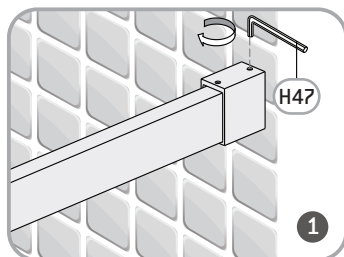
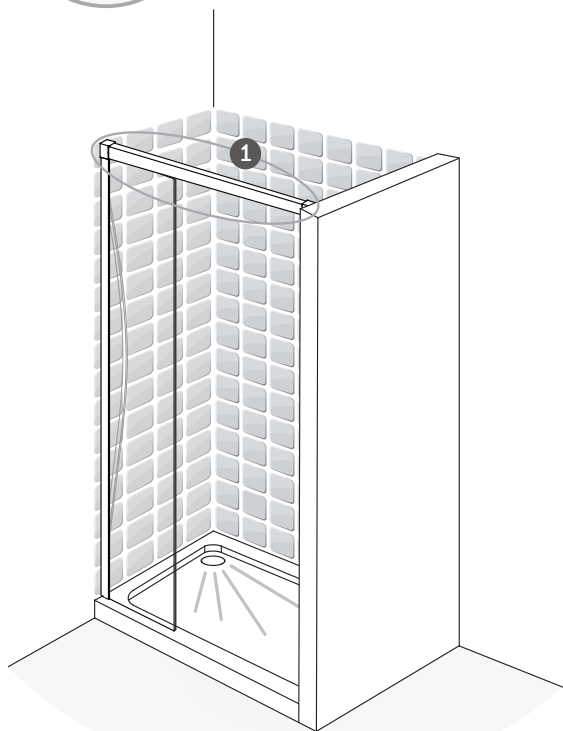
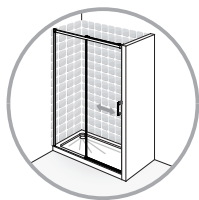

H47



x1

2.5mm





PH2 +

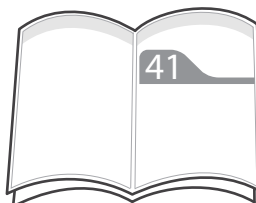
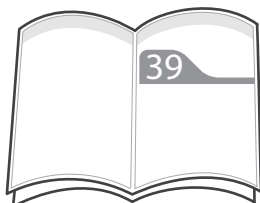
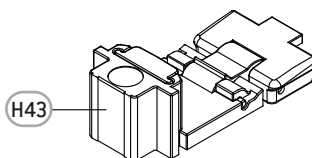
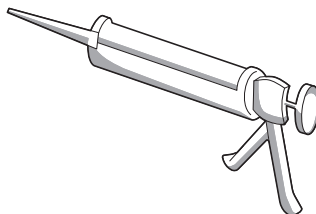
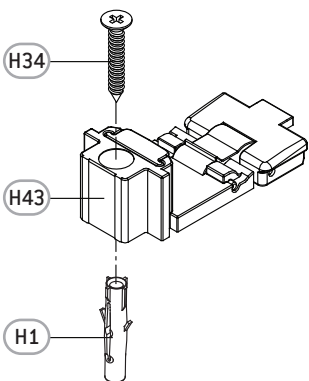

FR Montage

ES Montaje

PT Montagem

IT Montaggio

EL Συναρμολόγηση

PL Montaż

RU Сборка

UK Збірка

RO Montaj

EN Assembly

B

39

FR "Avertissement ! Vérifiez auprès du fabricant du receveur de douche que celui-ci peut être percé. Si ce n'est pas le cas, utilisez du silicone."

ES "¡Advertencia! Consulte con el fabricante del plato de la ducha si puede ser perforado. Utilice silicona en caso contrario."

PT "Aviso! Pergunte ao fabricante da base de chuveiro se esta pode ser perfurada. Se não for o caso, use silicone."

IT "Verificare con il produttore della colonna per la doccia se quest'ultima può essere forata. In caso contrario, utilizzare del silicone."

EL "Προειδοποίηση! Ρωτήστε τον κατασκευαστή ντουζιέρας εάν μπορεί να βιδωθεί. Εάν δεν γίνεται, χρησιμοποιήστε σιλικόνη."

PL "Ostrzeżenie! Prosimy sprawdzić u producenta brodzika, czy można w nim wierceć otwory. Jeśli nie, należy użyć silikonu."

RU "Предупреждение! Узнайте у производителя душевого поддона, допускается ли его сверление. В противном случае используйте силиконовый герметик."

UK "Увага! Зверніться до виробника душевого піддона щодо питання свердлення піддона. Якщо це неможливо, використовуйте силікон."

RO "Avertizare! Consultați-vă cu producătorul căditei de duș pentru a afla dacă această poate fi găurit. Dacă nu poate fi găurit, utilizați silicon."

EN "Warning! Check with shower tray's maker if it can be drilled. If not, use silicon."

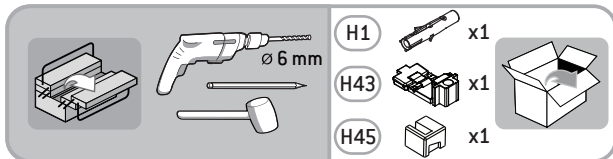
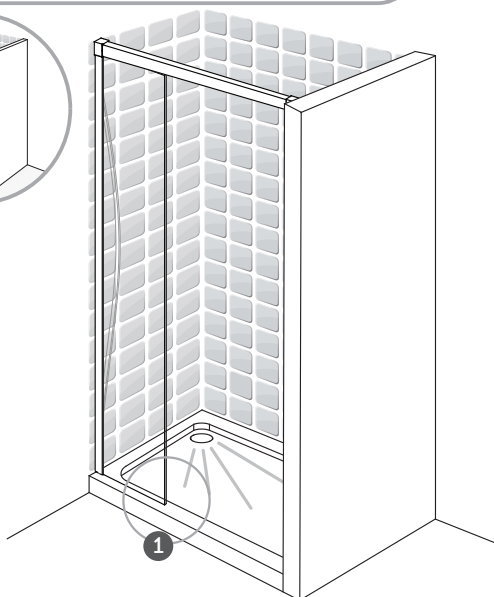
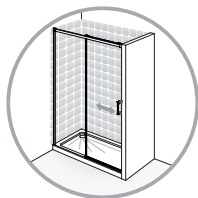
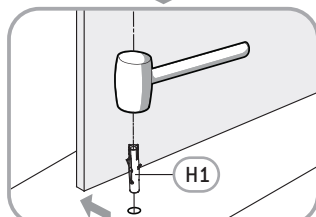
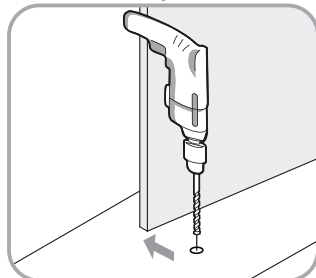
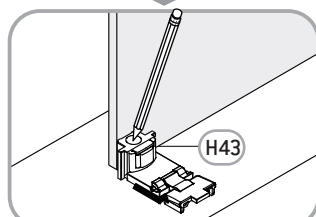
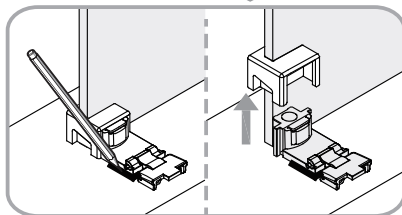
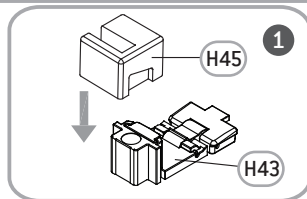

B

FR Montage

ES Montaje

PT Montagem

IT Montaggio

EL Συναρμολόγηση

PL Montaż

RU Сборка

UK Збірка

RO Montaj

EN Assembly

40

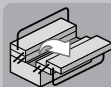
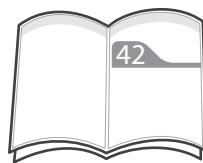
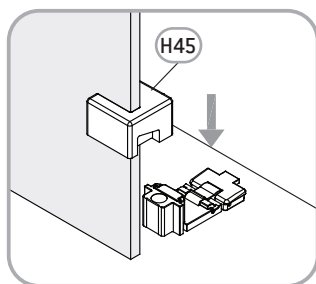
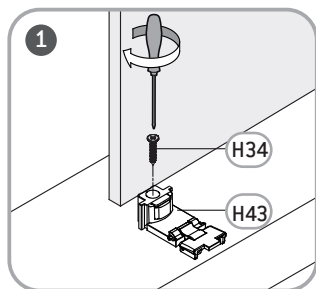
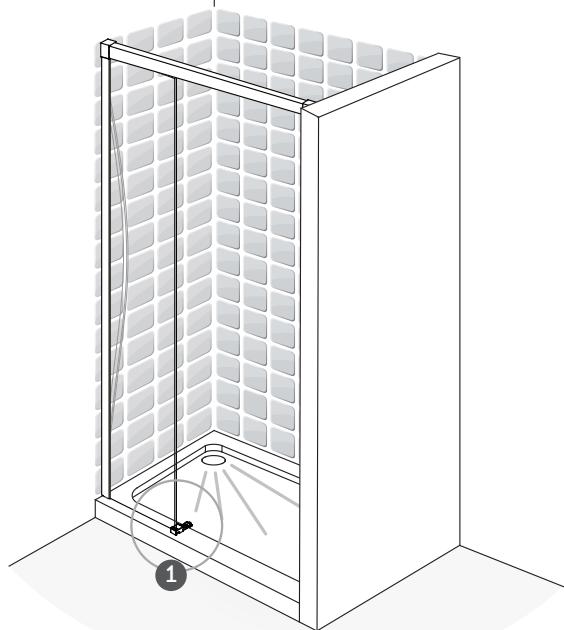
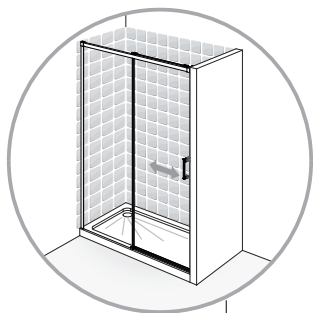
H34  x1

ST 4x30mm

H43  x1H45  x1

FR Montage

ES Montaje

PT Montagem

IT Montaggio

EL Συναρμολόγηση

PL Montaż

RU Сборка

UK Збірка

RO Montaj

EN Assembly

B

41

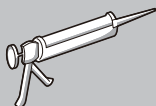
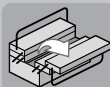
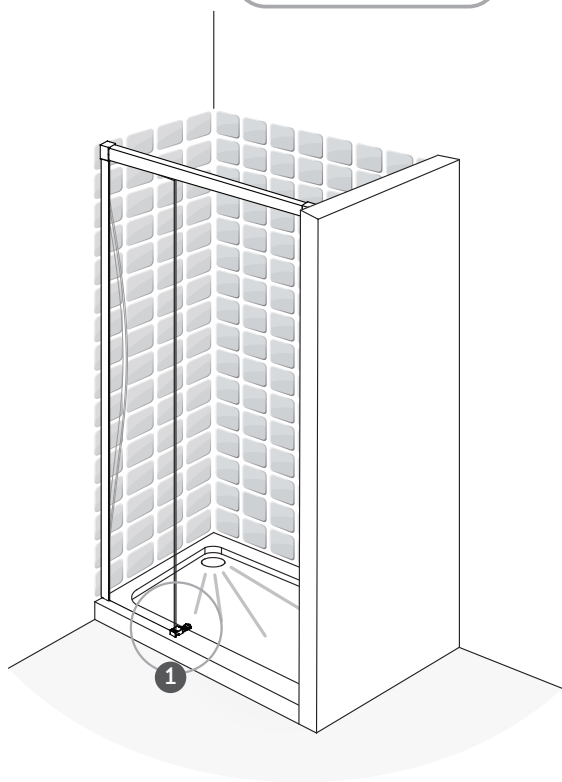
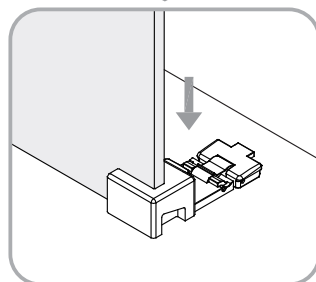
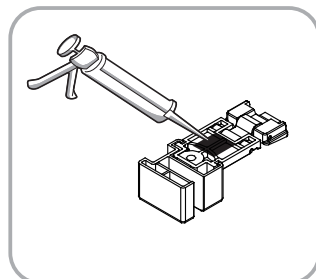
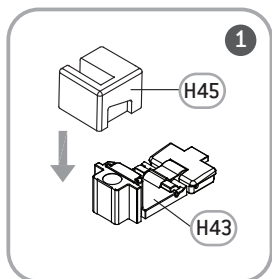
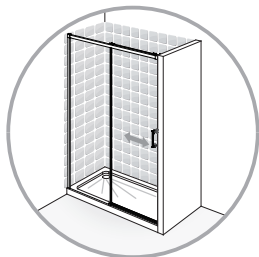

H43



x1

H45



x1



B

FR Montage

ES Montaje

PT Montagem

IT Montaggio

EL Συναρμολόγηση

PL Montaż

RU Сборка

UK Збірка

RO Montaj

EN Assembly

42

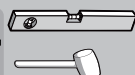
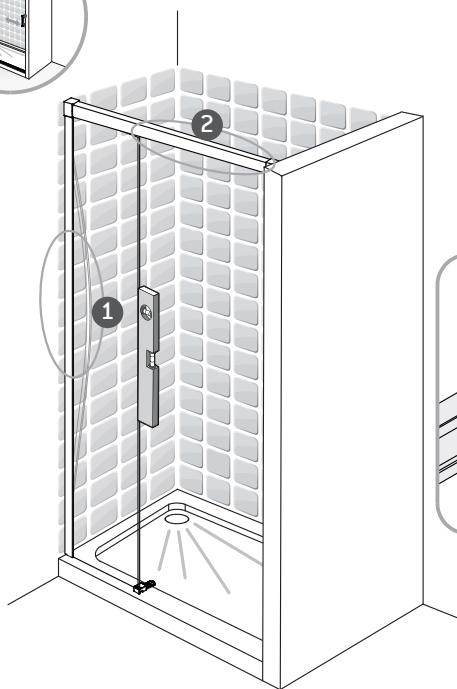
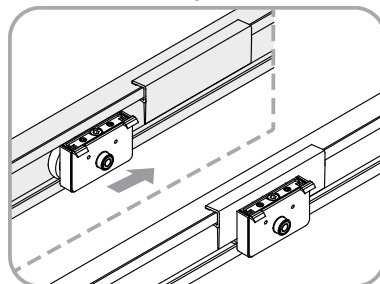
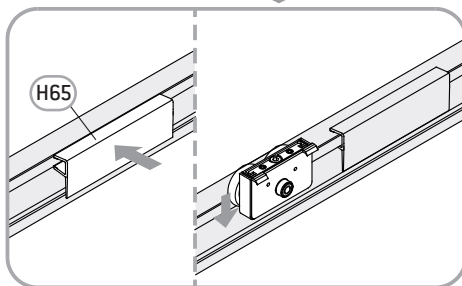
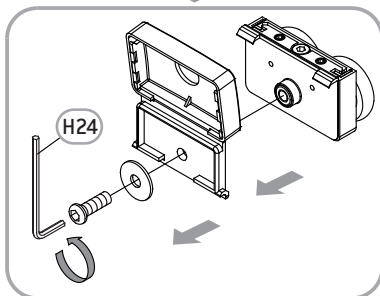
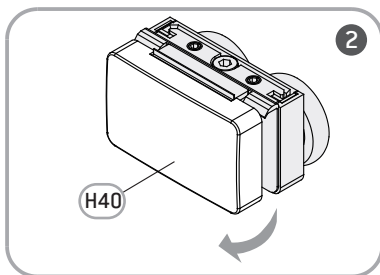
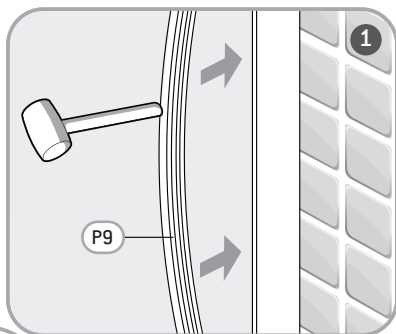

H40 x2

H24 3mm x1

H65 x2

FR Montage

ES Montaje

PT Montagem

IT Montaggio

EL Συναρμολόγηση

PL Montaż

RU Сборка

UK Збірка

RO Montaj

EN Assembly

B

43

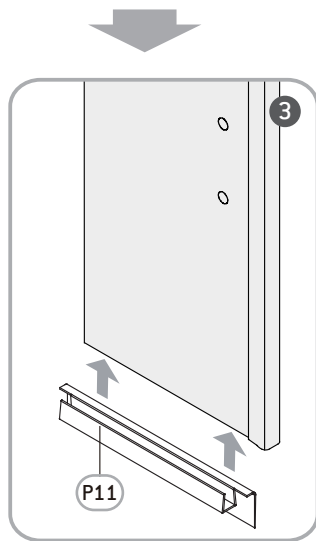
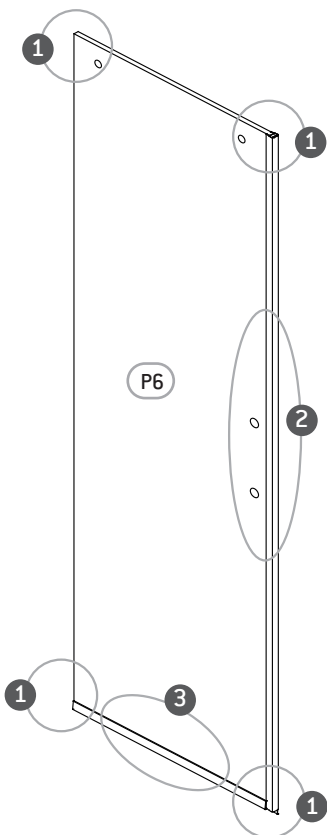
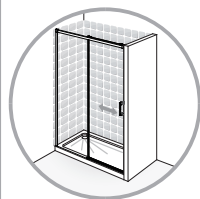
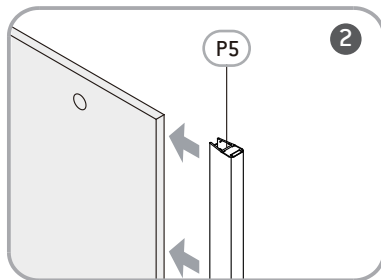
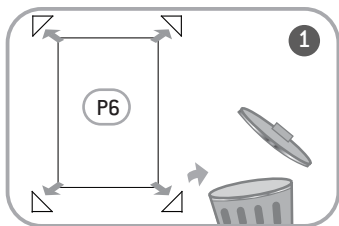

P11  x1

P6  x1

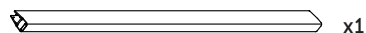
P5  x1



B

FR Montage

ES Montaje

PT Montagem

IT Montaggio

EL Συναρμολόγηση

PL Montaż

RU Сборка

UK Збірка

RO Montaj

EN Assembly

44

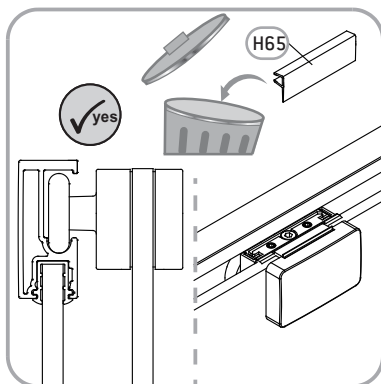
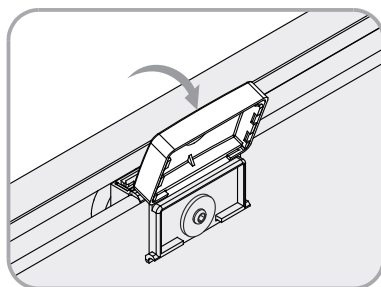
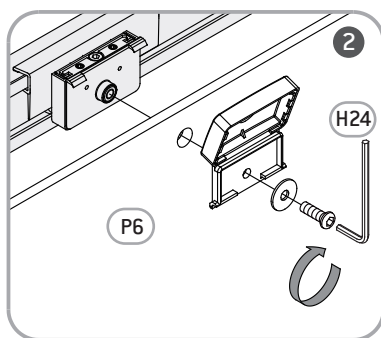
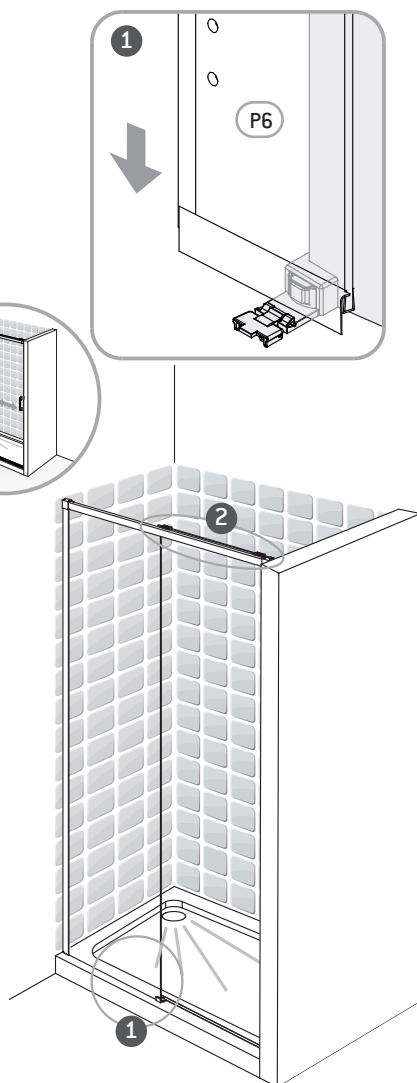
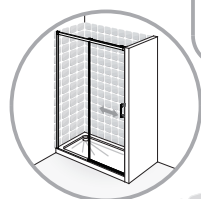

H24



x1



FR Montage

ES Montaje

PT Montagem

IT Montaggio

EL Συναρμολόγηση

PL Montaż

RU Сборка

UK Збірка

RO Montaj

EN Assembly

B

45

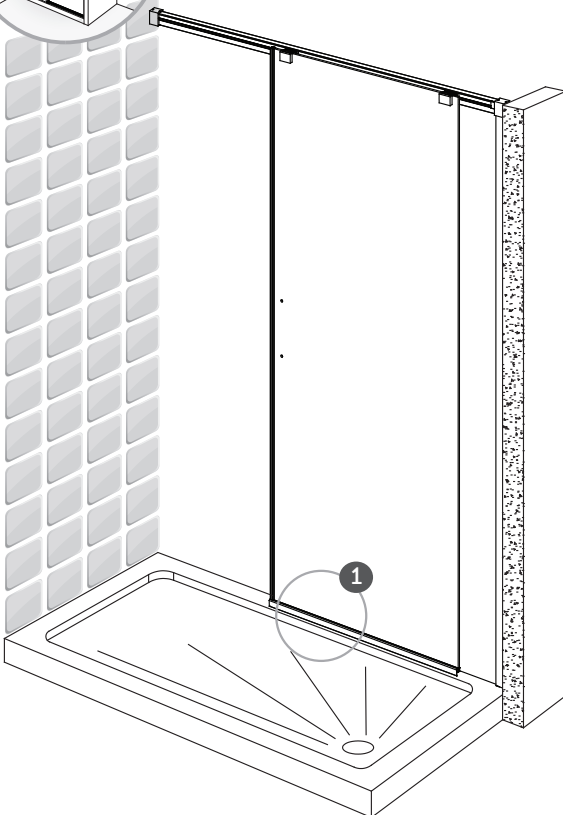
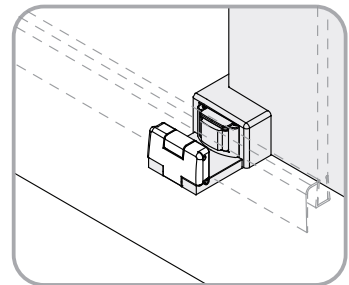
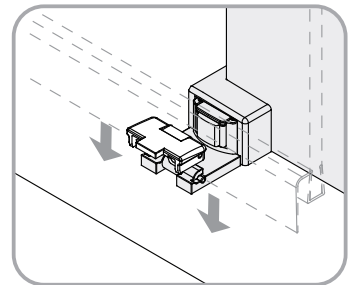
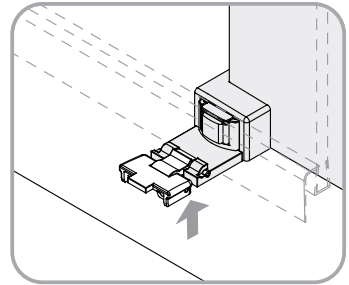
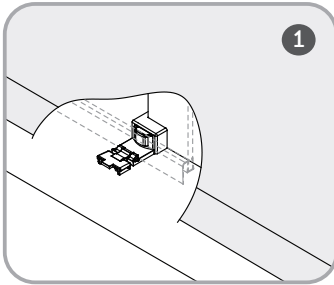

B

FR Montage

ES Montaje

PT Montagem

IT Montaggio

EL Συναρμολόγηση

PL Montaż

RU Сборка

UK Збірка

RO Montaj

EN Assembly

46

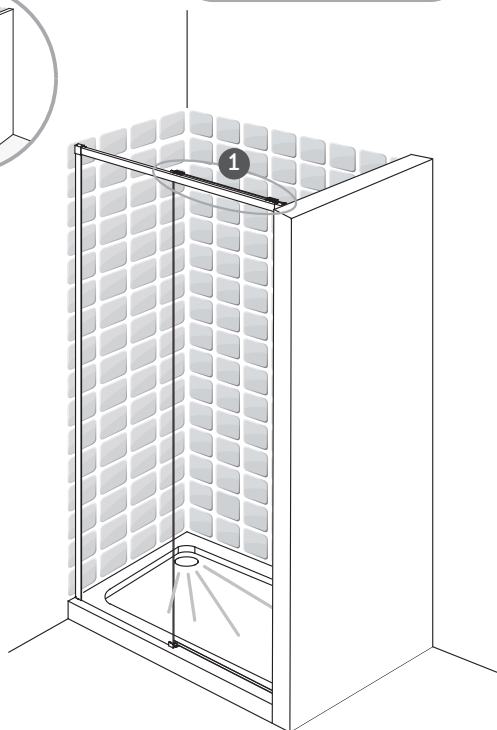
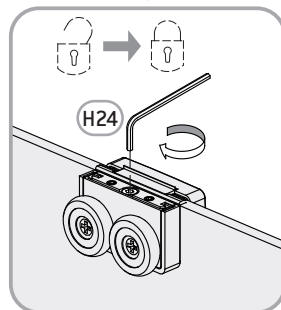
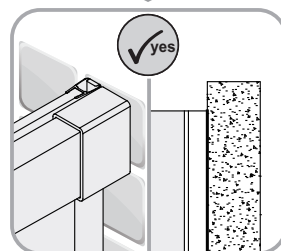
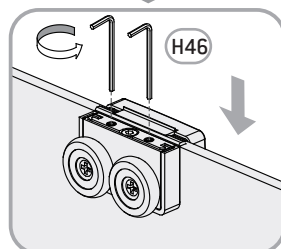
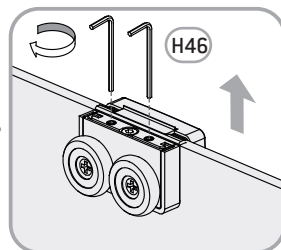
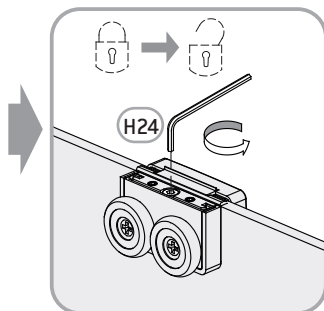
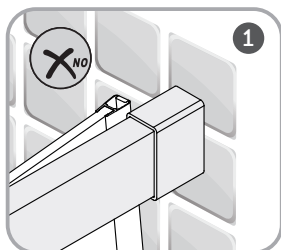

FR Montage

ES Montaje

PT Montagem

IT Montaggio

EL Συναρμολόγηση

PL Montaż

RU Сборка

UK Збірка

RO Montaj

EN Assembly

B

47

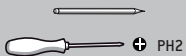
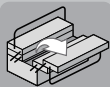
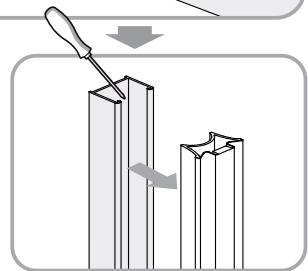
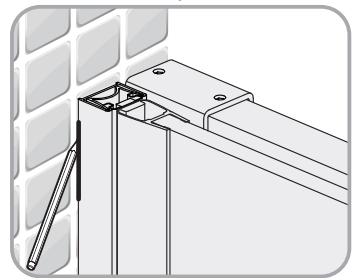
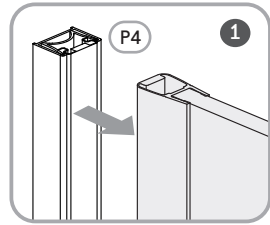
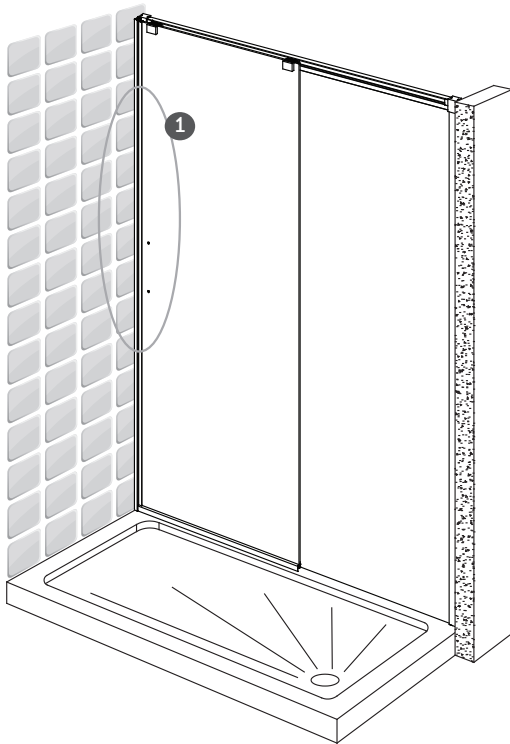

P4

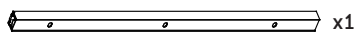

B

FR Montage

ES Montaje

PT Montagem

IT Montaggio

EL Συναρμολόγηση

PL Montaż

RU Сборка

UK Збірка

RO Montaj

EN Assembly

48

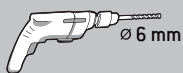
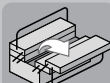
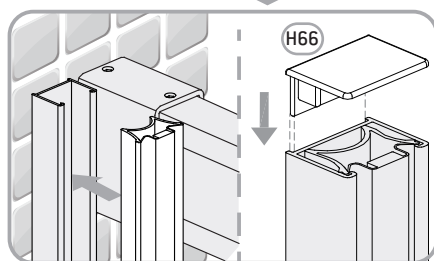
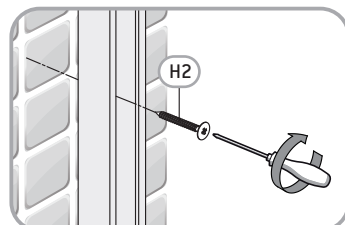
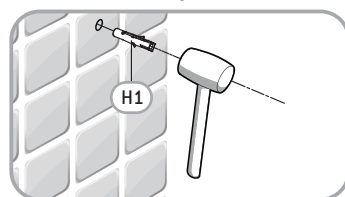
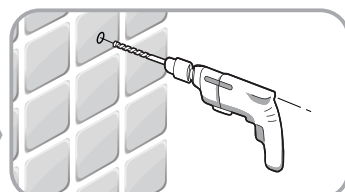
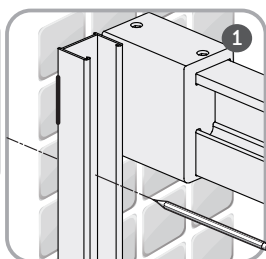
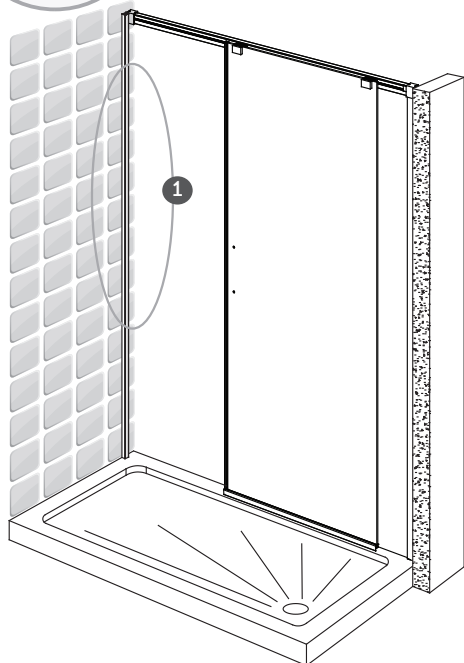
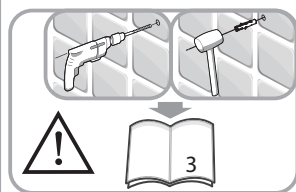

∅ 6 mm



PH2



x3



x3

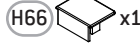

x1

ST 4x40mm



x1



x1



FR Montage

ES Montaje

PT Montagem

IT Montaggio

EL Συναρμολόγηση

PL Montaż

RU Сборка

UK Збірка

RO Montaj

EN Assembly

B

49

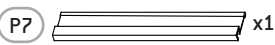
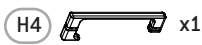
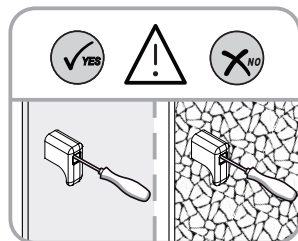
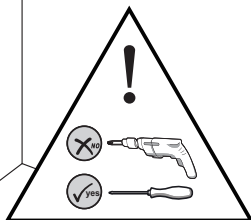
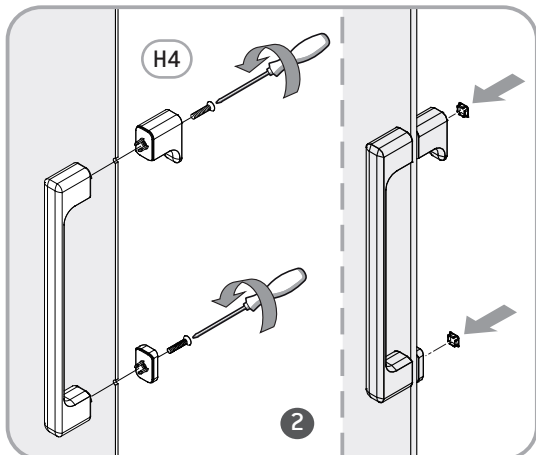
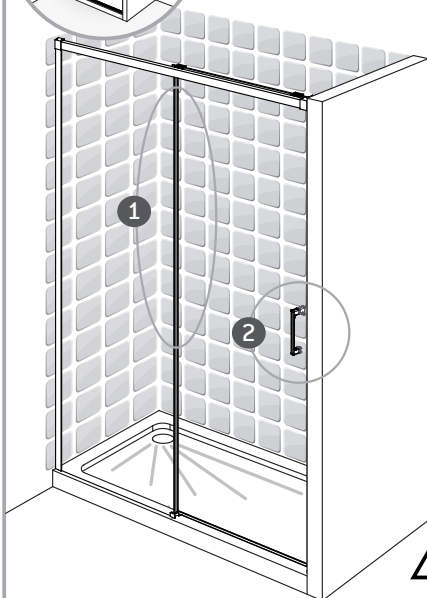
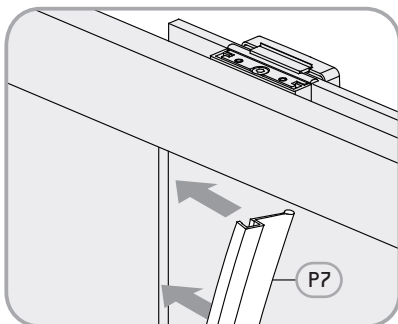
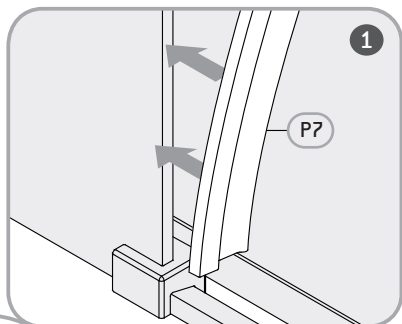

B

FR Montage

ES Montaje

PT Montagem

IT Montaggio

EL Συναρμολόγηση

PL Montaż

RU Сборка

UK Збірка

RO Montaj

EN Assembly

50

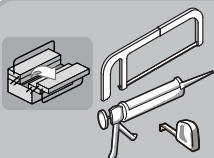
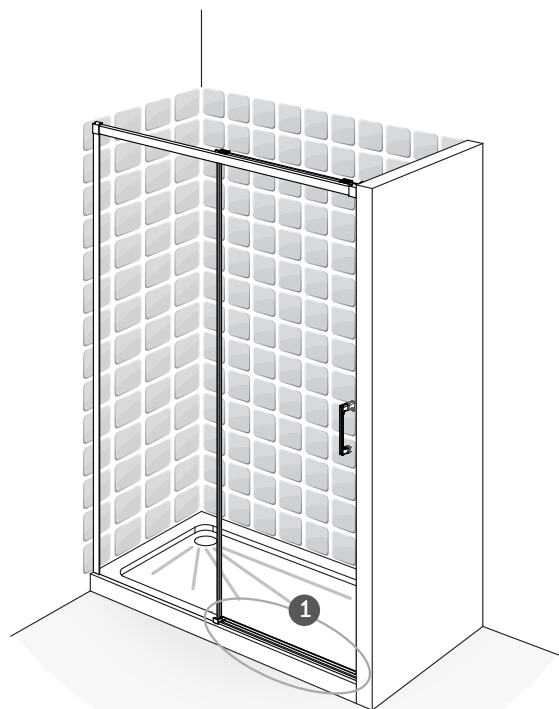
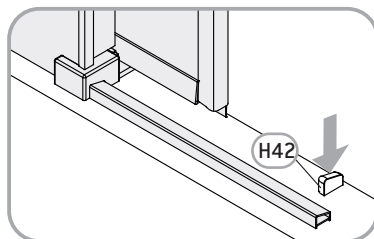
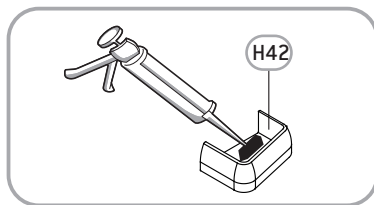
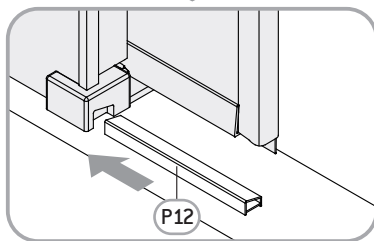
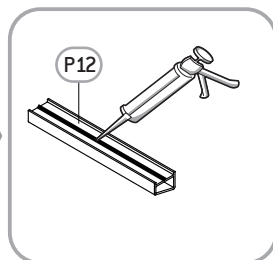
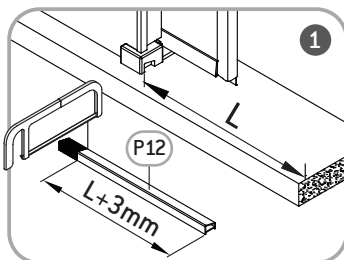

H42 x1



P12 x1

FR Montage

ES Montaje

PT Montagem

IT Montaggio

EL Συναρμολόγηση

PL Montaż

RU Сборка

UK Збірка

RO Montaj

EN Assembly

B

51

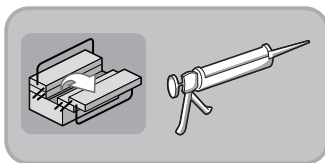
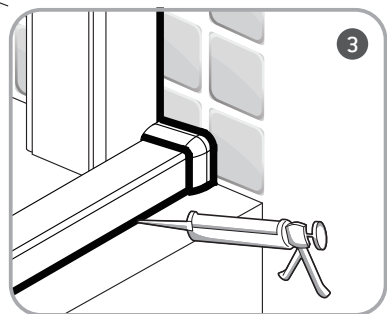
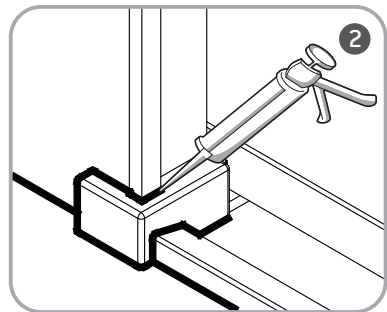
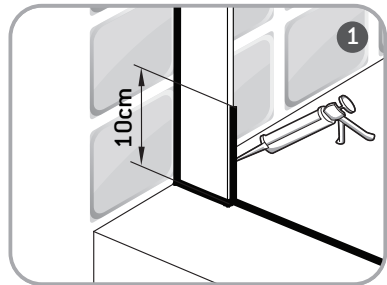
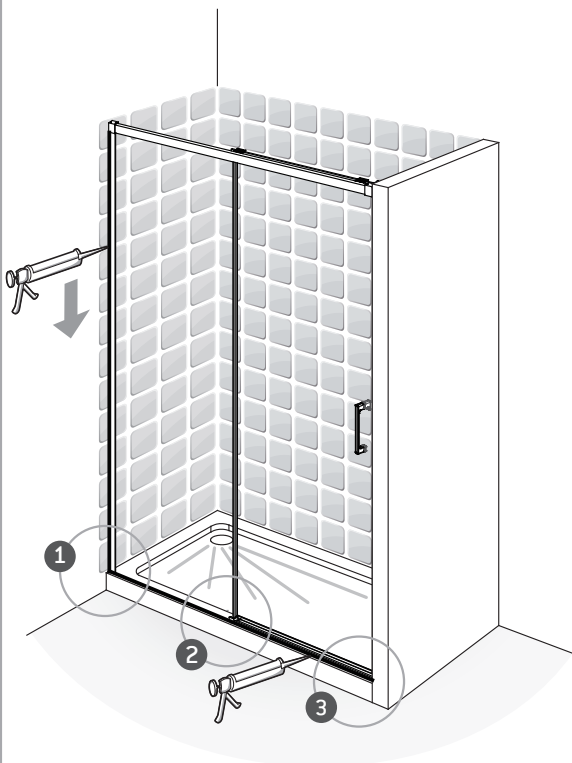
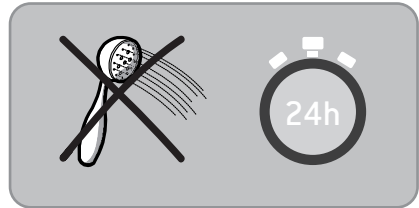

C**FR** Entretien**ES** Mantenimiento**PT** Serviço**IT** Manutenzione**EL** Συντήρηση**PL** Konserwacja**RU** Уход**UK** Догляд**RO** Întreținere**EN** Maintenance

Sans solvant / Sin disolvente / Sem solventes / Senza solventi / Χωρίς διαλυτικά / Bez rozpuszczalnika / Без растворителя /
Без розчинника / Fără solvent / Solvent-free

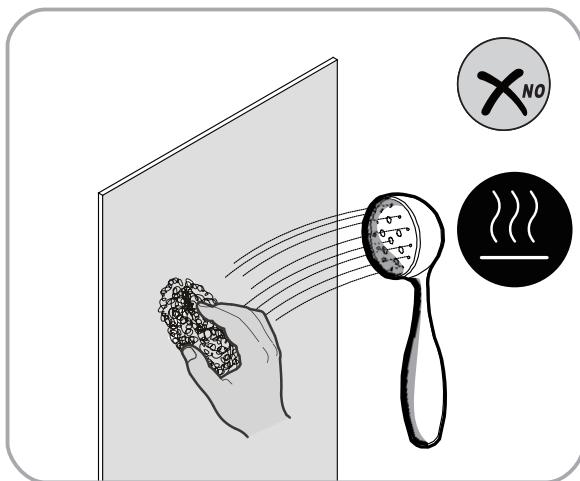
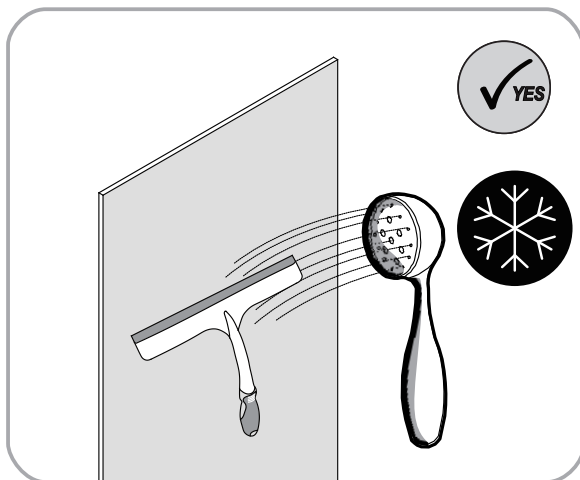

FR



ADEO Services - 135 Rue Sadi Carnot - CS 00001 59790 RONCHIN - France
16
EN 14428:2015

Code d'identification unique du produit-type: **
usage prévu: hygiène personnelle
Nettoyable: Conforme
Résistance à l'impact/
Capacité de Fragmentation: Conforme
durabilité: Conforme

DOP N ° 204003/0001/2016

ES



ADEO Services - 135 Rue Sadi Carnot - CS 00001 59790 RONCHIN - France
16
EN 14428:2015

Código de identificación única del producto tipo: **
Uso previsto: higiene personal
Limpiable: Conforme
Resistencia al impacto/
Capacidad de fragmentación: Conforme
Durabilidad: Conforme

DOP N ° 204003/0001/2016

PT



ADEO Services - 135 Rue Sadi Carnot - CS 00001 59790 RONCHIN - France
16
EN 14428:2015

Código de identificação único do produto-tipo: **
Utilização prevista: higiene pessoal
Limpeza: Conforme
Resistência ao impacto/
Capacidade de fragmentação: Conforme
Durabilidade: Conforme

DOP N ° 204003/0001/2016

IT



ADEO Services - 135 Rue Sadi Carnot - CS 00001 59790 RONCHIN - France
16
EN 14428:2015

Codice di identificazione unico del prodotto-tipo: **
Uso previsto: igiene personale
Pulibile: Conforme
Resistenza agli urti/
Capacità di Frammentazione: Conforme
Durata: Conforme

DOP N ° 204003/0001/2016

EL



ADEO Services - 135 Rue Sadi Carnot - CS 00001 59790 RONCHIN - France
16
EN 14428:2015

Μοναδικός κωδικός ταυτοποίησης του τύπου του προϊόντος: **
προβλεπόμενη χρήση: προσωπική υγιεινή
Δυνατότητα καθαρισμού: Σύμφωνα με
Αντοχή σε κρούση/ Ικανότητα κατάτμησης: Σύμφωνα με
Διάρκεια: Σύμφωνα με

DOP N ° 204003/0001/2016

PL



ADEO Services - 135 Rue Sadi Carnot - CS 00001 59790 RONCHIN - France
16
EN 14428:2015

Niepowtarzalny kod identyfikacyjny typu wyrobu: **
przeznaczenie: higiena osobista
Możliwość czyszczenia: Zgodny
Odporność na uderzenia/
Rozkruszalność: Zgodny
Trwałość: Zgodny

DOP N ° 204003/0001/2016

RU



ADEO Services - 135 Rue Sadi Carnot - CS 00001 59790 RONCHIN - France
16
EN 14428:2015

Уникальный идентификационный код типа изделия: **
Назначение: личная гигиена
Легкость очистки: Соответствие
Ударопрочность/
Мощность распыления: Соответствие
Долговечность: Соответствие

DOP N ° 204003/0001/2016

UK



ADEO Services - 135 Rue Sadi Carnot - CS 00001 59790 RONCHIN - France
16
EN 14428:2015

Унікальний ідентифікаційний код виду продукції: **
призначення: особиста гігієна
Легкість очищення: Відповідність
Ударостійкість/
Потужність розпилення: Відповідність
Довговічність: Відповідність

DOP N ° 204003/0001/2016

RO



ADEO Services - 135 Rue Sadi Carnot - CS 00001 59790 RONCHIN - France
16
EN 14428:2015

Cod unic de identificare a tipului de produs: **
destinație: igienă personală
Posibilitatea de curățare: Conform
Rezistență la impact/
Capacitate de fragmentare: Conform
Durabilitate: Conform

DOP N ° 204003/0001/2016

EN



ADEO Services - 135 Rue Sadi Carnot - CS 00001 59790 RONCHIN - France
16
EN 14428:2015

Unique identification code of the product-type: **
Intended use: personal hygiene
cleanability: Pass
Impact resistance/ shatter properties: Pass
Durability: Pass

DOP N ° 204003/0001/2016

**

FR Reportez-vous à l'annexe.

ES Consulte el apéndice.

PT Consulte o anexo.

IT Consultare l'appendice.

EL Ανατρέξτε στο Παράρτημα.

PL Patrz załącznik.

RU См. приложение.

UK Читайте додаток.

RO Consultați anexa.

EN Refer to appendix.

ADEO Services
135 Rue Sadi Carnot
CS 00001
59790 RONCHIN - France

ТОВ «Леруа Мерлен Україна»,
вул. Полярна 17а, м. Київ
04201, Україна

ООО ЛЕРУА МЕРЛЕН ВОСТОК,
141031, Московская область,
Мытищинский район, г. Мытищи,
Осташковское шоссе, д.1, РОССИЯ

* Garantie 3 ans / Garantía 3 años / Garantia 3 anos / Garanzia 3 anni
Εγγύηση 3 ετών / Gwarancja 3 lat / 3 летняя / 3-річна гарантія
3 ani garanție / Guarantee 3 years

Made In P. R.C. 2016